



HOTHING



深圳市和信国际家居有限公司 出品

官网 | www.hothing.vip

全国服务热线 | 4000 999 039





HOTHING

一个具有独立设计语言的
原创生活品牌

HOTHING 和信国际，品牌诞生于设计之都深圳，是一个具有独立语言设计的原创生活品牌。其标志性的曲线设计，成为行业极具识别度且少数派的存在，是先锋前卫的代名词。HOTHING 不仅是一个坚定而大胆的设计品牌，也是中国工艺的诚挚捍卫者。HOTHING 的核心价值是“少数派”，源于“less is more”坚持“少即是多，物以稀为贵”的价值理念。与众不同的风格，得益于对传统手工艺的研究和当代美学的功力。HOTHING 作品不但大量使用天然稀有原料，力求无瑕的工艺细节，而且体现了对环境的敬畏之心。HOTHING 的作品拥有完美的线条和材料。不断追求卓越的抱负和对细节一丝不苟的关注，越简单越难，越难越向前。HOTHING Life，不止于家具的原创生活，一种精英生活的优雅态度。好看的皮囊千篇一律，有趣的灵魂万里挑一，不是所有的品牌都具备自己的独立语言，HOTHING 以高品质的原创设计作品，致敬卓越眼光的少数派！

和信国际是一家集设计研发,生产制造,品牌服务,市场销售于一体的国际先锋家具品牌, 2017 年 Hothing 在深圳创立, 在惠州拥有 3 万平方的生产基地, 特立独行的产品风格一出场便给人留下了深刻的印象。少数派, 名字里就带着股不善于服从的傲气, 一直坚持着“西装暴徒”的迷人魅力。以家具为核心载体, 营造生活方式, 以设计服务为驱动给消费者带来系统化的消费体验, 每个人心中都有一只独角兽, 它代表着特立独行的少数派, HOTHING 的每一座生活美学馆, 都是一个汇聚“有趣灵魂”的地方, 气质相近的优秀总能相互吸引, HOTHING 致敬眼光卓越的少数派!

HOTHING is an international pioneer furniture brand integrating design and development, manufacturing, brand service, marketing and sales, HOTHING was founded in Shenzhen in 2017, with a production base of 30,000 square meters in Huizhou. Minority, with a disobedient arrogance in its name, has always adhered to the charming charm of "thugs in suits". With furniture as the core carrier, we create a lifestyle, and bring consumers a systematic consumption experience driven by design services. Everyone has a unicorn in their hearts, it represents a maverick minority, every life aesthetics museum in HOTHING is a place where "interesting souls" gather, excellent people with similar temperament can always attract each other, HOTHING pays tribute to the minority with excellent vision!

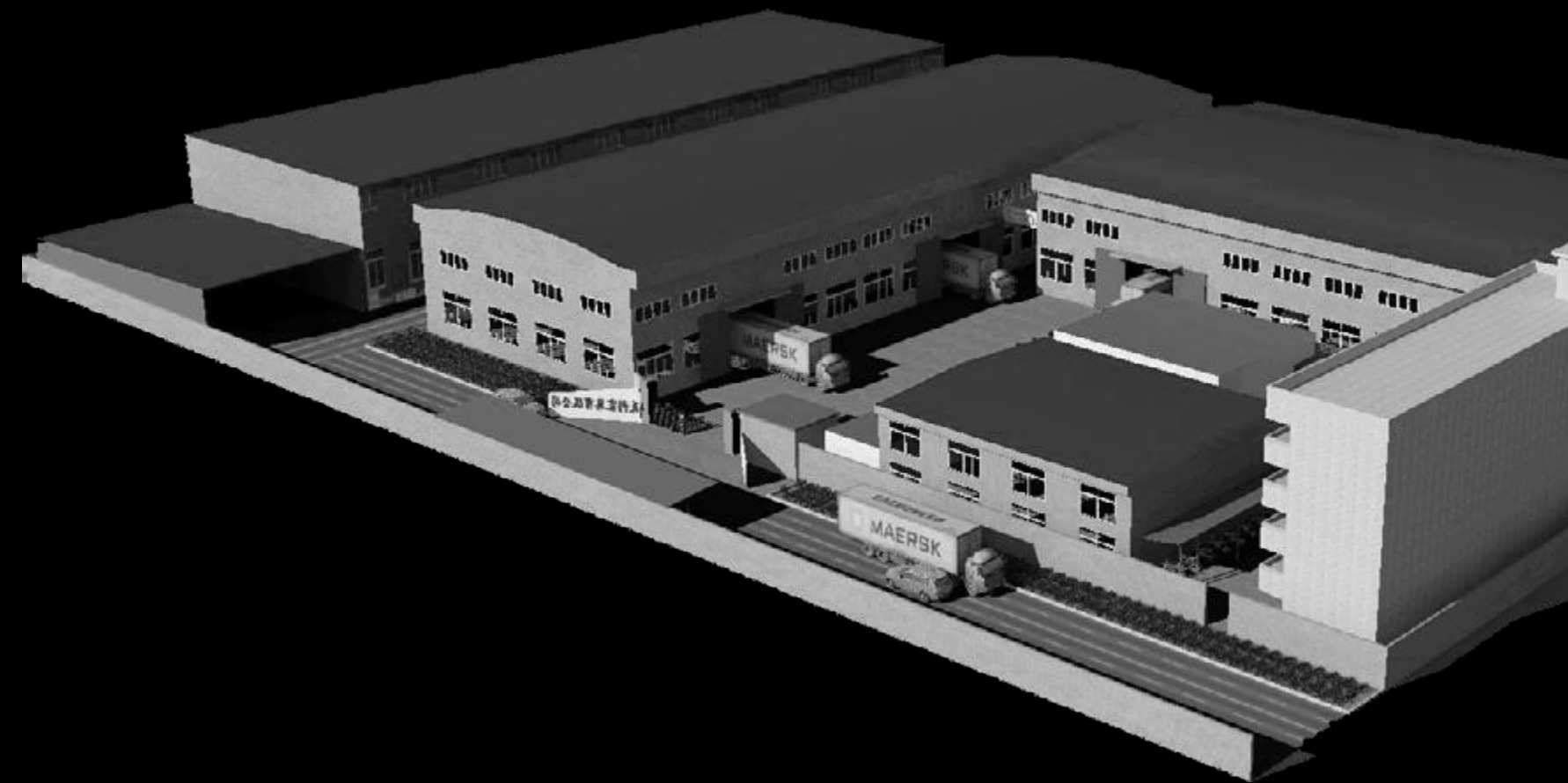

Design Power

原创设计力量

HOTHING 和信国际设计汇聚来自全球的原创设计力量，他们中有些是在中国乃至国际都享有声誉的知名设计师，有些则是像我们一样逐渐成长起来的新锐青年设计师。我们相信，好的设计比名字更有说服力。正因为如此，我们才能与每一位设计师建立长期稳定的关系，这种稳固的合作也更有利于设计师与我们品牌的深入了解，共同快速成长。

HOTHING brings together original designers from all over the world, some of them are well-known designers with good reputation in China and even internationally, while some of them are young designers who are growing up like us. We believe that good design is more persuasive than a name. Because of this, we are able to establish a long-term and stable relationship with each designer, and this solid cooperation is also more conducive to a deeper understanding of the designer and our brand, and rapid growth together.



Baptiste Dosne



Floriane Dosne

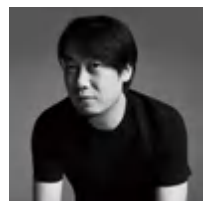

陈大瑞



何东晓



孔武



黄犇

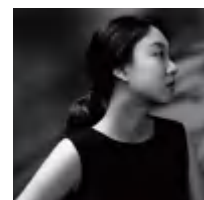

王蕴涵

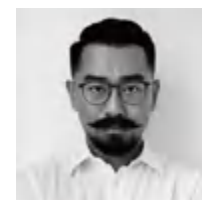

李质光



王鸿



张沙



黄涵



陈楠



HOTHING 全球终端网点现已布局全国 80 余家
超 1000 m² 旗舰店近 20 家

CONTENTS

沙发 SOFA	013
单人位 ARMCHAIR	161
茶几 COFFEE TABLE	225
餐桌 DINING TABLE	273
扶手椅 CHAIR	327
边柜 SIDEBOARD	351
床 BED	363
床头柜 BEDSIDE TABLE	427
凳类 STOOLS	439
梳妆台 DRESSING TABLE	447
书房 STUDY SYSTEM	455
茶室 TEA SYSTEM	475
配饰 ACCESSORY	498

SOFAS

沙发





THE GAME 大玩家

灵感来自少数派的玩趣精神，在快节奏的社会发展中，人们利用游戏的心态来调节自己、释放压力，他们当然也希望长久陪伴自己的家具可以充满“游戏性”。产品形态灵活多变，可以随心所欲地组装、堆叠、延伸，我们可以像小时候玩积木一样的随意组合它们，在拆散、拼接、变化中重拾童年的乐趣，创造专属的生活方式。

Embracing the minority's lighthearted spirit, in today's fast-paced society, people embrace a playful approach to self-regulation and stress relief. They desire furniture that exudes "playfulness" while being durable. This flexible and customizable furniture allows for creative assembly, stacking, and extension, reminiscent of childhood building block play, providing an avenue to reclaim joy, and cultivate a unique lifestyle.

模块化的组合方式，可以随心所欲地组装、堆叠、延伸，几乎可以满足任何空间，以不被定义、始终坚持创新的产品设计和形式，传递 HOTHING 的设计哲学和品牌理念。

The modular combination method allows for unlimited assembly, stacking, and extension to suit any space, reflecting HOTHING's inventive product design philosophy and brand concept.





编号: HT253B 沙发

主材: 实木框架、桦木脚、A3 钢

尺寸: 2400*1200*630H (mm)

Model: HT253B Sofa

Main material: Solid wood, level of steel

Size: 2400*1200*630H (mm)

PRODUCT MODULES

产品模块组合图

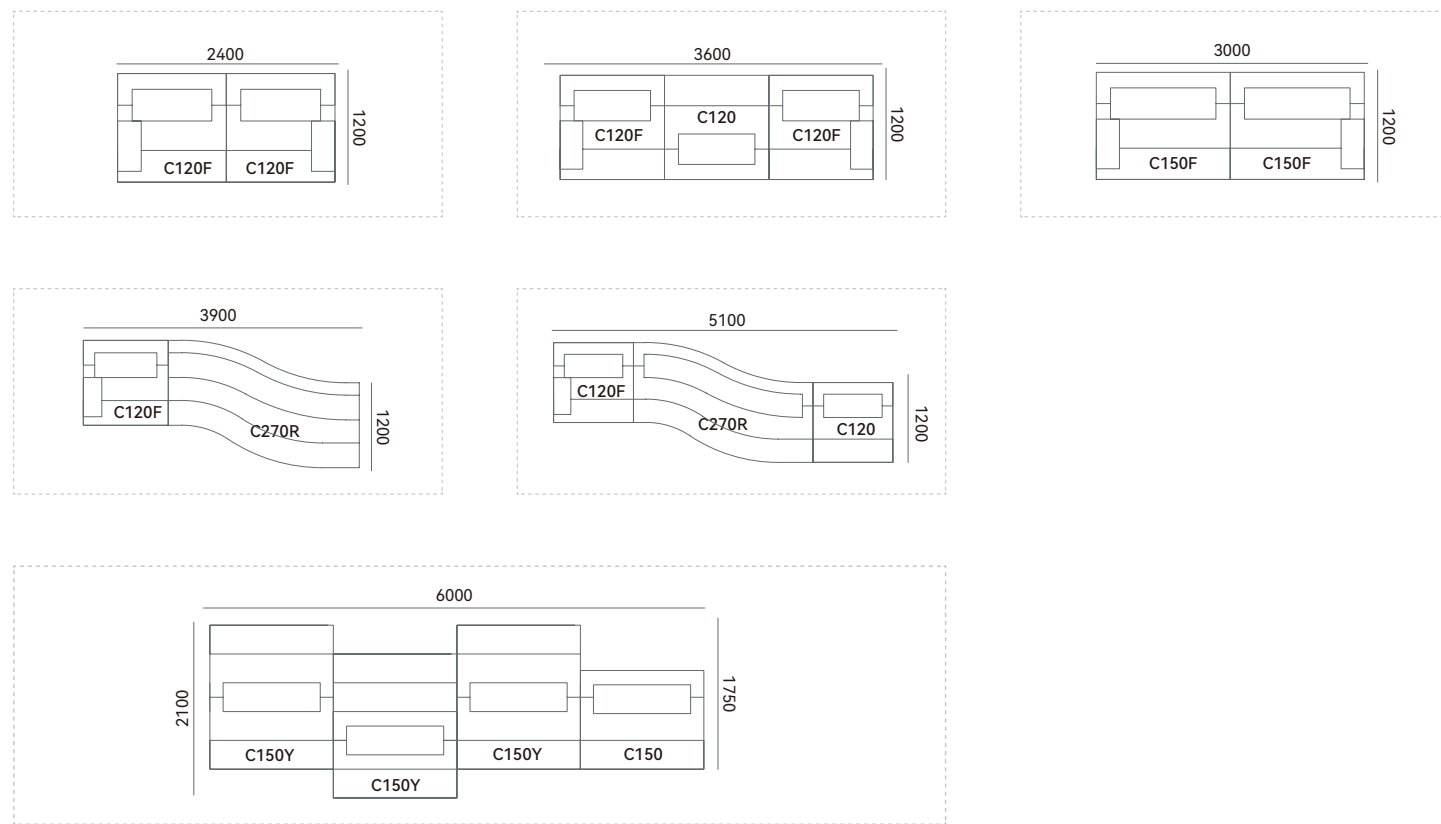





COBBLE 群岛

整个沙发仿佛一座座的小岛组成的群岛，每个小岛都有不同的形状，可以组合也可以拆分，聚散疏离在自己的心居地栖息；宽大圆润的靠背和坐深拉伸空间大气从容的格调，富有肌理感的面料，耐脏耐磨的同时凸显简约线条，整个造型亦是自成一派的风景。

The sofa resembles an archipelago with small, differently shaped islands that can be combined or separated. Its wide and round backrest offers a spacious seating area, with elegant style and durable, stain-resistant fabric, creating a unique and tranquil look.



编号: HT258 沙发

主材: 内架实木、内架多层实木板

尺寸: 6100*3275*750H (mm)

Model: HT258 Sofa

Main material: Solid wood

Size: 6100*3275*750H (mm)



PRODUCT MODULES

产品模块组合图

悬浮式的沙发脚设计，似海平面上若有似无的悬浮感，为空间注入透气感，立体又通透。圆润的靠背和宽大的坐深，可盘腿坐，休闲放松。

The suspended sofa leg design brings a floating sensation at sea level, adding a breathable and transparent ambience to the space. With its rounded backrest and wide seating depth, it allows for relaxed, cross-legged sitting.

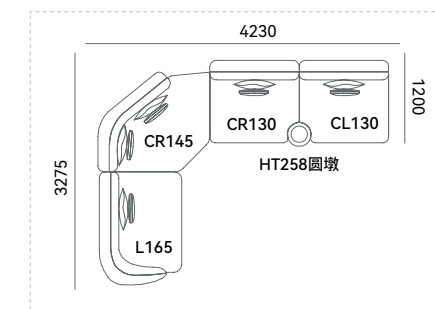
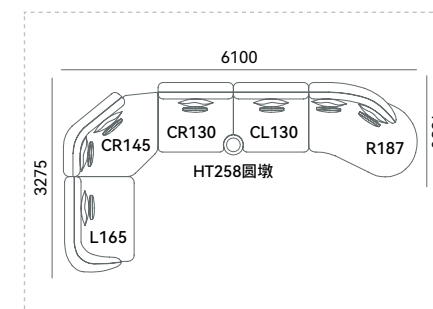
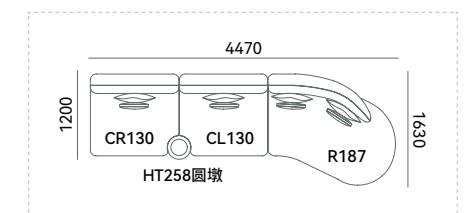
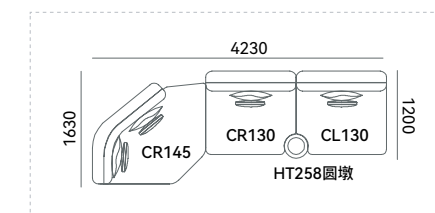
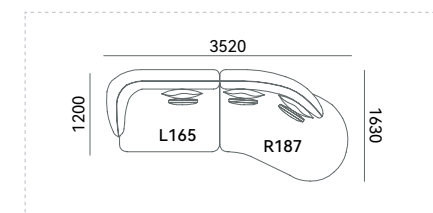
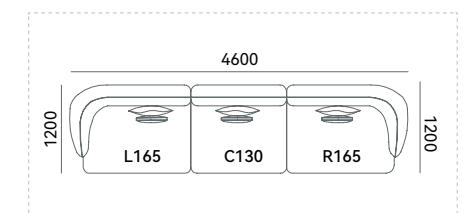
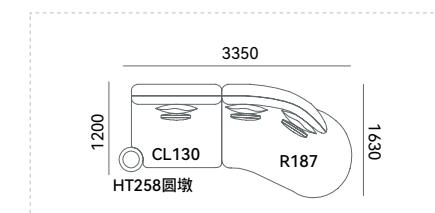
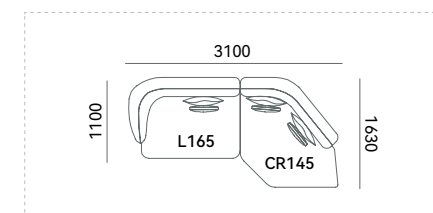







CASUAL 写意

打破了固定的公式时刻传达着尝试改变，不被定义的内核，放松随意的 Casual 沙发，在糅合现代主义和理性主义的思想，更平添一份刚与柔的微妙平衡。模块化的自由组合方式，让沙发在不同的空间中都可以很好地生长，拥抱更加多元的可能性和张弛有道生活态度。

Disrupting the traditional approach, it consistently represents the essence of embracing change and defying definition. With its fusion of modernism and rationalism, the Casual sofa strikes a subtle equilibrium between firmness and softness. Its modular, versatile design enables it to thrive in various settings, embracing diverse possibilities and a laid-back lifestyle.

编号: HT228 沙发

主材: 内架多层实木板、桦木、石材、不锈钢

尺寸: 3985*2155*700H (mm)

Model: HT228 Sofa

Main material: Solid wood, Birch, Marble, Stainless steel

Size: 3985*2155*700H (mm)







PRODUCT MODULES

产品模块组合图

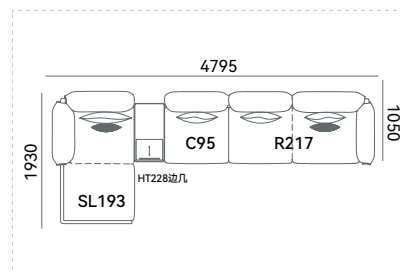
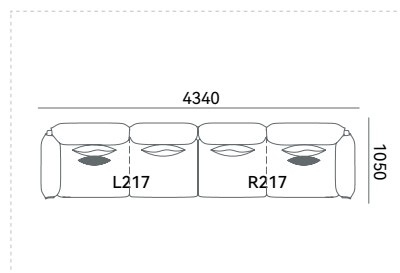
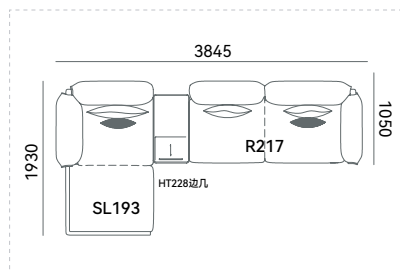
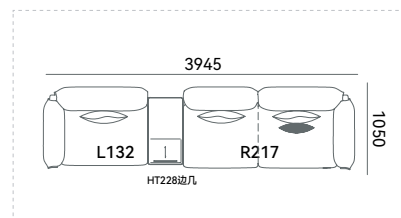
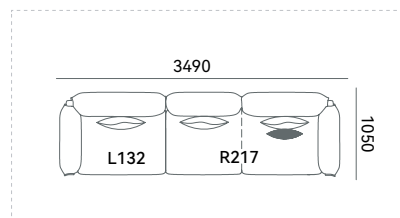
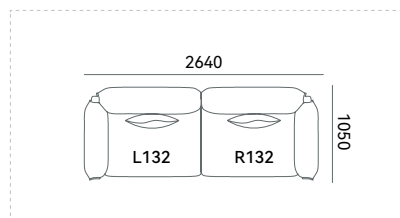



CITYWALK

城墙

城墙沙发的设计灵感来源于包豪斯时期的建筑特色，强调实用性和舒适性。沙发采用模块化设计，可以根据不同的空间需求和个人喜好进行自由组合。每个模块都具有宽大的座深和高靠背，为用户提供极大的舒适感和安全感。整体造型简洁流畅，颜色淡雅，营造出舒适内敛的生活美学。

The Citywalk sofa draws inspiration from Bauhaus architecture, prioritizing functionality and comfort. Its modular design allows for customizable combinations to suit different spaces and preferences, featuring generous seat depth and high backrests for comfort and safety. With its simple, elegant style and limited color palette, it represents a comfortable lifestyle aesthetic.





编号: HT279 沙发
主材: 内架多层实木板、不锈钢
尺寸: 5070*2830*850H (mm)

Model: HT279 Sofa
Main material: Solid wood, Stainless steel
Size: 5070*2830*850H (mm)



PRODUCT MODULES

产品模块组合图

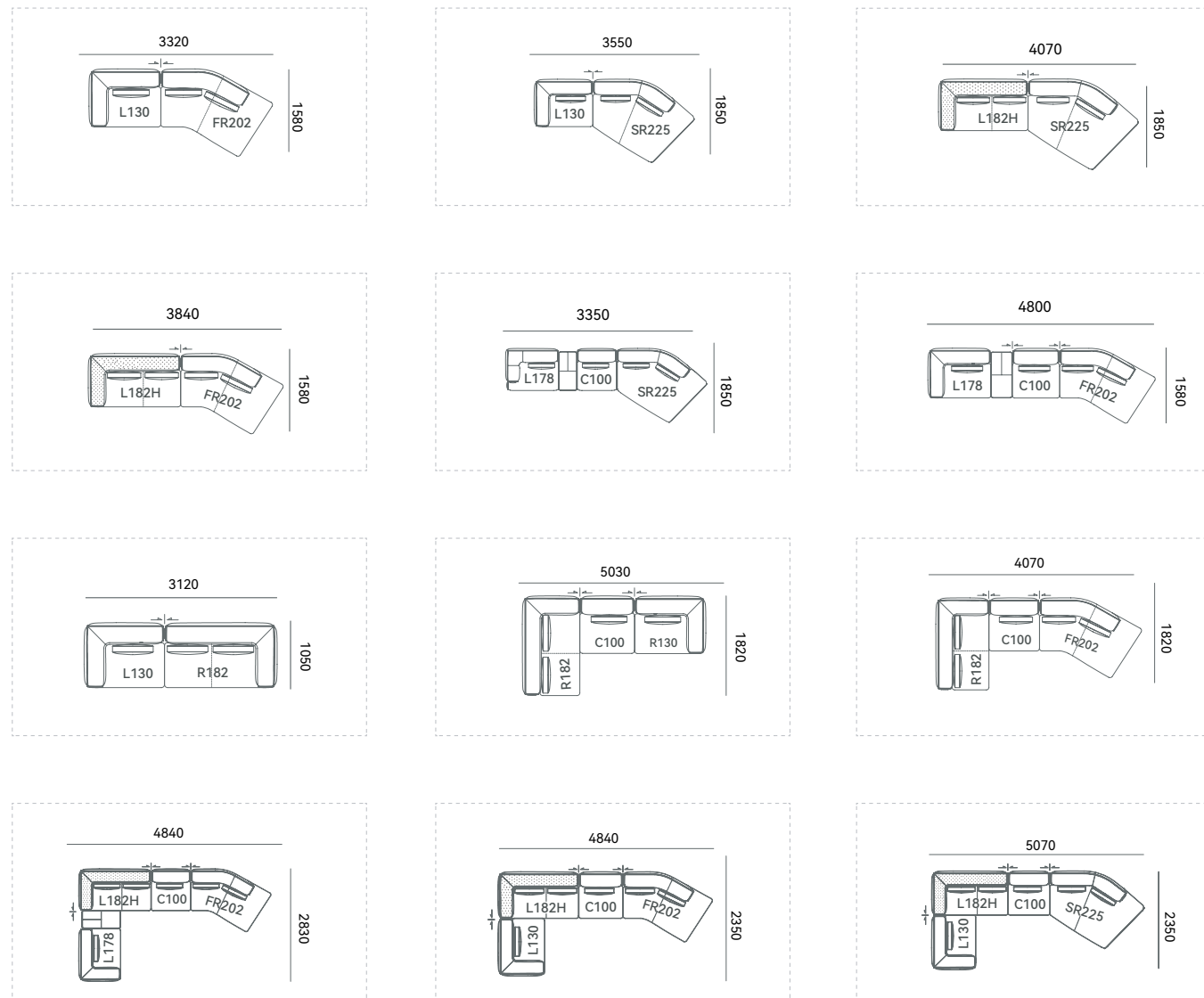





NAUTICA 诺蒂卡

诺蒂卡的命名来源于拉丁语 "nauticus"，意为 "航行"。正如其名，Nautica 象征着自由、冒险和追逐梦想的海洋精神。将船舶的外形化作少数派的灵感缪斯，多种材质的碰撞表达了不被定义的生活方式。

The name Nautica comes from the Latin "nauticus", meaning "to sail". Reflecting freedom, adventure, and the sea, Nautica represents the spirit of sailing and a diverse lifestyle through the combination of ship-inspired design and mixed materials.

编号: HT263 沙发

主材: 内架多层实木板、不锈钢

尺寸: 4240*2660*710H (mm)

Model: HT263 Sofa

Main material: Solid wood, Stainless steel

Size: 4240*2660*710H (mm)



PRODUCT MODULES

产品模块组合图

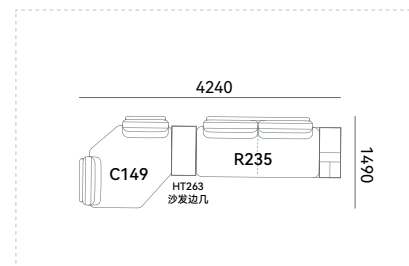
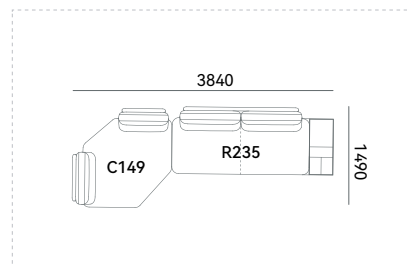
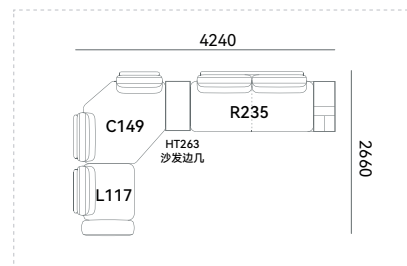
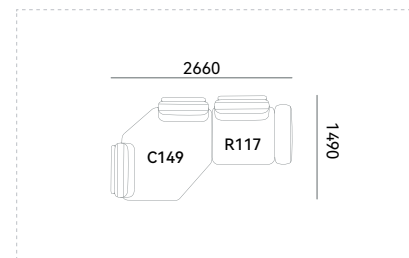
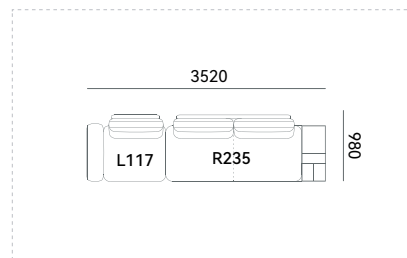
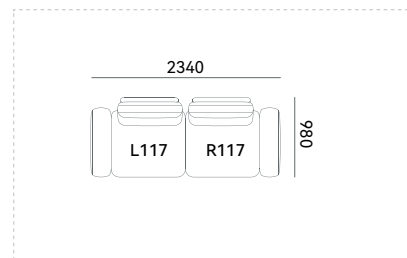





NATURE 简然

简然沙发以利落直线替代圆润线条，整体风格温和精致，始于颜值忠于坐感，邂逅不一样的舒适，让浪漫在心头蔓延。生活总是很慢，沙发也需要足够的温柔和包容，灵魂才能跟得上脚步，但愿这张沙发可以陪伴你走过无数个春秋。

The Nature sofa features clean, straight lines and a gentle, elegant style. It's designed for comfort and romance, catering to a slow-paced life and offering soulful companionship through many seasons.

编号: HT229 沙发

主材: 内架多层实木板、石材、不锈钢

尺寸: 4580*3050*750H (mm)

Model: HT229 Sofa

Main material: Solid wood, Marble, Stainless steel

Size: 4580*3050*750H (mm)



PRODUCT MODULES

产品模块组合图











KINGSMAN 总裁

总裁沙发刚柔并济恰到好处的分寸感，就像笔挺的男人穿了身得体的西装，概念灵感来自内外兼修的总裁气度，集端庄、性感、优雅于一身，将一丝不苟的精湛工艺，以玩世不恭的幽默与风趣，对抗世界的循规蹈矩。

The Kingsman sofa embodies the dignified, sexy, and elegant temperament of a president, reflecting meticulous craftsmanship and cynical humor in its design.



编号: HT252 沙发

主材: 内架多层实木板、桦木、不锈钢

尺寸: 3520*1450*780H (mm)

Model: HT252 Sofa

Main material: Solid wood, Stainless steel

Size: 3520*1450*780H (mm)

PRODUCT MODULES

产品模块组合图

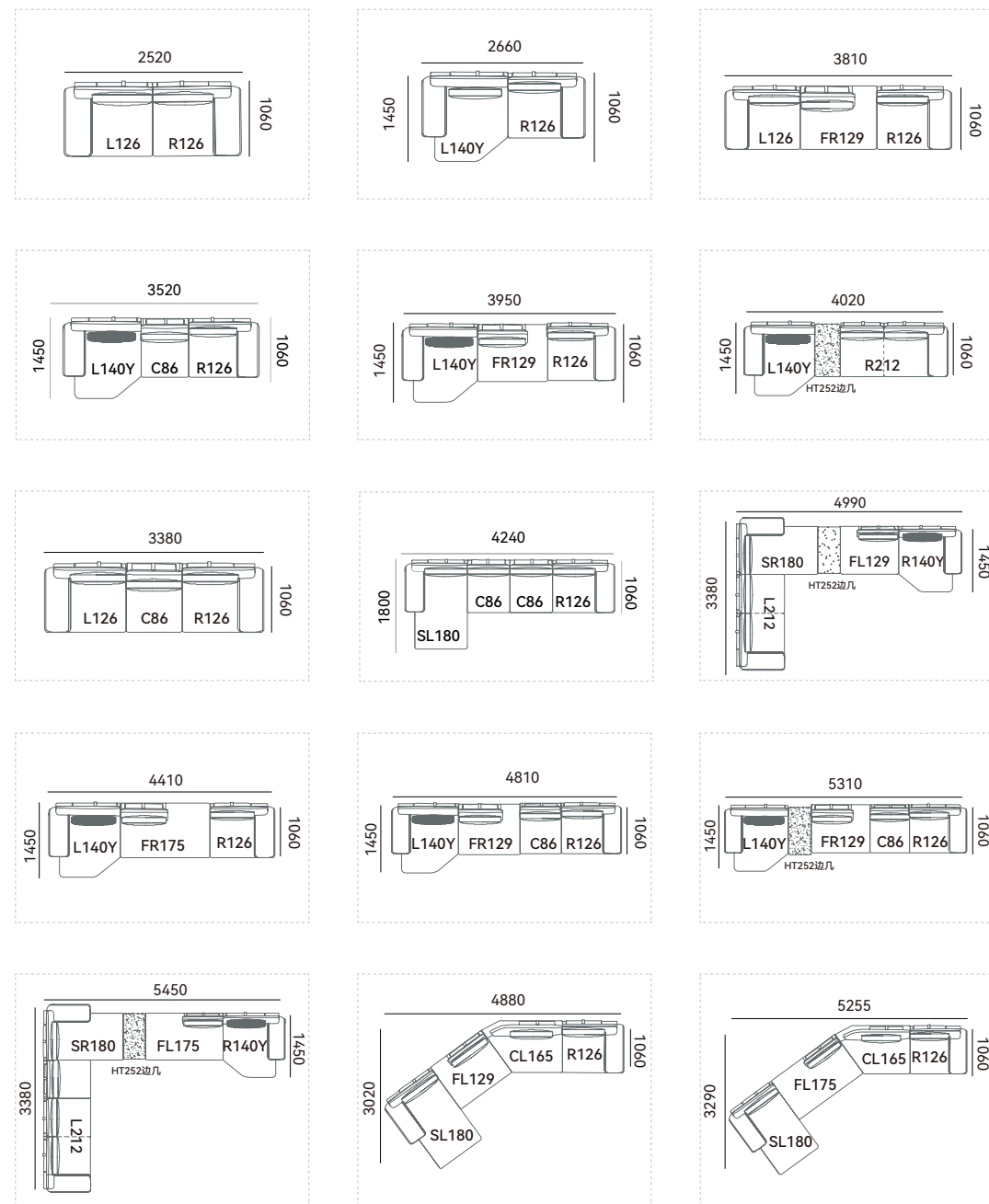





ARM 臂弯

少数派的强劲臂弯，简洁中饱含力量，如同一位东方谦谦君子，兼具理性的坚定和感性的包容。方正有型的外表下，幻化出极简美学的非凡格调。沙发的宽大曲线，如同爱人的臂弯宽厚有力，给人一种低调内敛却又具有亲和力的魅力。

The minority's strong arms exude strength through simplicity, resembling the rational firmness and emotional tolerance of a modest Eastern gentleman. Minimalist aesthetics imbue the square and stylish appearance with an extraordinary style, while the sofa's wide curves convey a friendly charm with their low-key and restrained appeal.



PRODUCT MODULES

产品模块组合图

编号: HT256 沙发

主材: 内架多层实木板、石材、不锈钢

尺寸: 5265*2970*720H (mm)

Model: HT256 Sofa

Main material: Solid wood, Marble, Stainless steel

Size: 5265*2970*720H (mm)

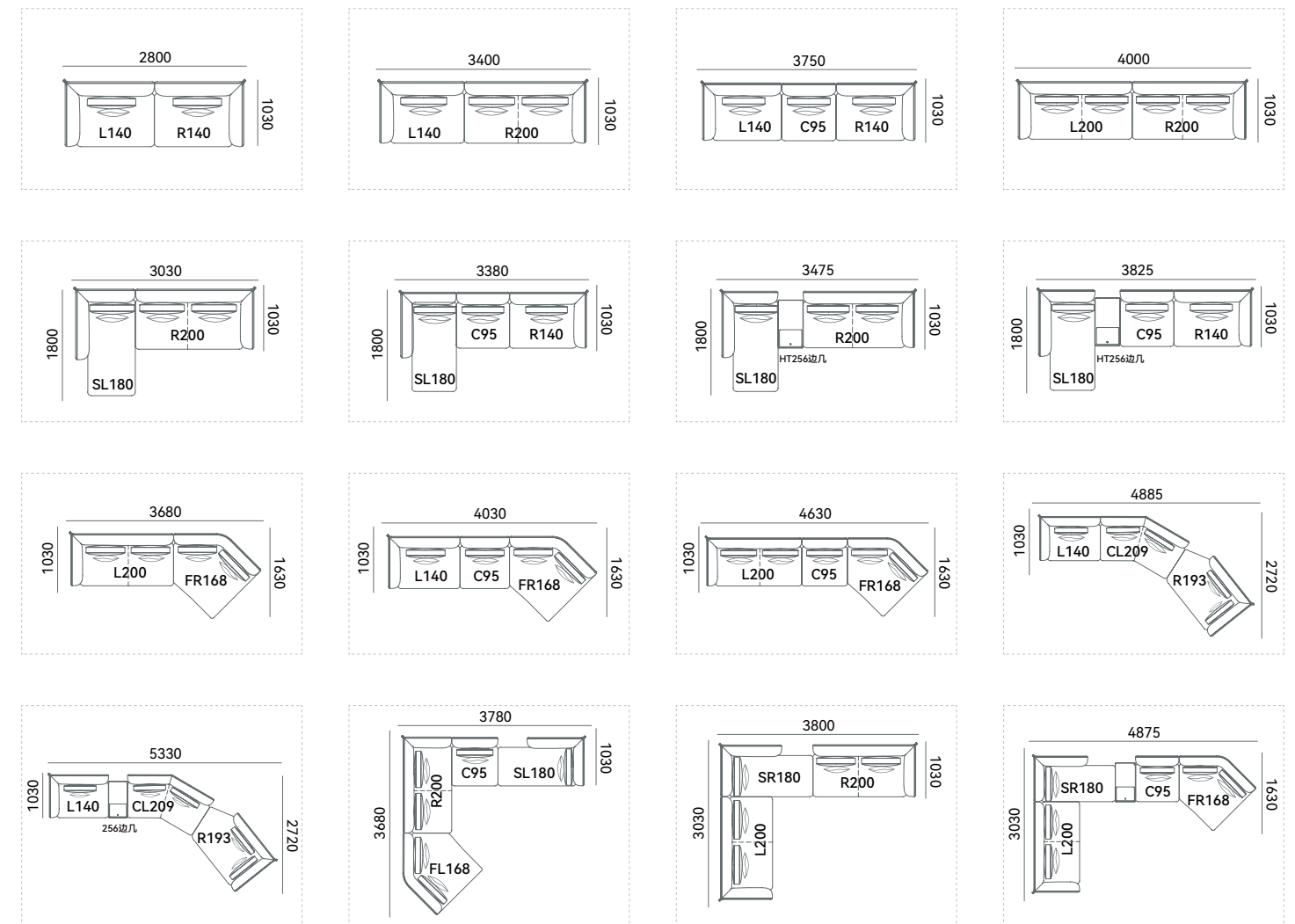







The Moon and Sixpence C 位沙发

大多数人会说：“满地都是六便士，他却抬头看见了月亮”，而少数派选择是：去发光，而不是被照亮。C 位沙发来自月半弯的灵感，是一种东方诗意的表达。之所以取名为“C 位”，不仅因型似 C 型，更因其气场，是沙发界妥妥的 C 位控场大师。

The ground was supposedly filled with sixpence, yet he chose to look up and catch sight of the moon. The C-position sofa takes inspiration from the half bend reference to the moon in oriental poetry. Named for its C shape and powerful aura, it stands as a master of field control in the sofa industry.

编号: HT260 沙发

主材: 内架多层实木板、不锈钢

尺寸: 3830*1840*650H (mm)

Model: HT260 Sofa

Main material: Solid wood, Stainless steel

Size: 3830*1840*650H (mm)





PRODUCT MODULES

产品模块组合图









ATLAS 托举

"Atlas" (阿特拉斯) 沙发的灵感源自古希腊神话中的阿特拉斯，象征力量与支持。沙发外形融合了力量感与柔和曲线，宛如阿特拉斯的身姿，为现代家居提供舒适休息的空间。丰富的层次和软垫设计展现了雕塑般的美感，同时保持舒适性。

The "Atlas" sofa draws inspiration from the myth of Atlas, presenting a blend of strength and soft curves for a comfortable yet sculptural design that symbolizes support and resilience in modern homes.

编号: HT275 沙发

主材: 内架实木、内架多层实木板、石材

尺寸: 3740*1300*720H (mm)

Model: HT275 Sofa

Main material: Solid wood, Marble

Size: 3740*1300*720H (mm)

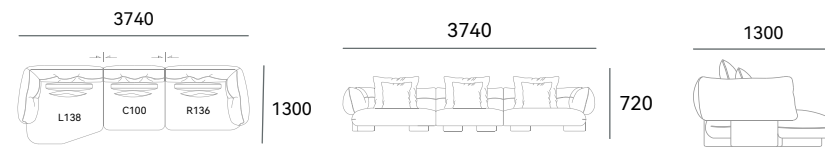





QUEEN 女王

设计灵感来自电影《穿普拉达的女王》，致敬独立自主的精神，她们不屈于角色定位，敢于追求自己的梦想和目标，懂生活会生活。真正的女王是骨子里透露出来的自信以及精神绝对的富足，一款女王沙发，愿每一个女孩，都拥有独一无二的人生，做自己的女王。

The design is influenced by "The Devil Wears Prada" and celebrates independence. It rejects conventional roles, encourages pursuing dreams and embodies self-confidence and a rich spirit. The Queen sofa aims for every girl to live a unique life and be her own queen.

编号: HT270 休闲沙发 -S280
主材: 内架多层实木板、不锈钢
尺寸: 2800*1030*800H (mm)

Model: HT270 Sofa
Main material: Solid wood, Stainless steel
Size: 2800*1030*800H (mm)

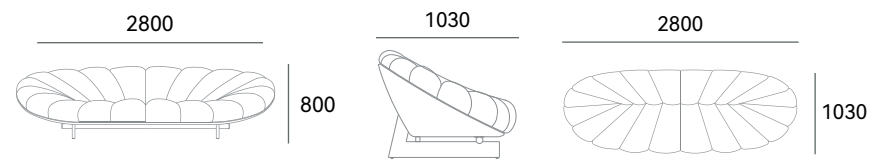



BOREAL 北极

编号: HT272 沙发

主材: 内架实木、内架多层实木板、石材、贴皮

尺寸: 4290*1410*760H (mm)

Model: HT272 Sofa

Main material: Solid wood, Marble, Veneer

Size: 4290*1410*760H (mm)

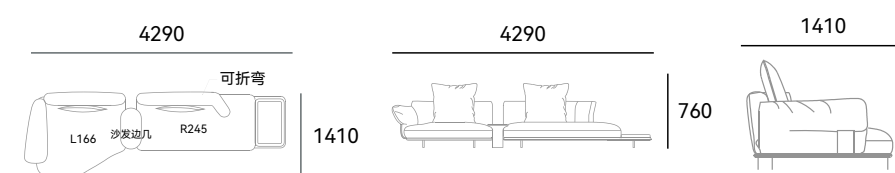

“Boreal”这个名字源自拉丁语，意为北方。设计理念旨在将北欧的自然美景和简约生活方式融入现代家居之中。沙发以流畅的线条和冷静的色调设计，映射出北极的雪地和冰川，给人一种北方风景的宁静与平和之感。

"Boreal" originates from the Latin word for "north". The design concept blends the natural beauty and minimalist lifestyle of Northern Europe into modern home décor. With its sleek lines and serene tones, the sofa reflects the snow and glaciers of the Arctic, evoking a sense of tranquility and peace reminiscent of northern landscapes.





GEOMETRY 几何

编号: HT276 沙发

主材: 多层实木板、五金、玻璃

尺寸: 5675*3120*690H (mm)

Model: HT276 Sofa

Main material: Solid wood, Metal, Glass

Size: 5675*3120*690H (mm)

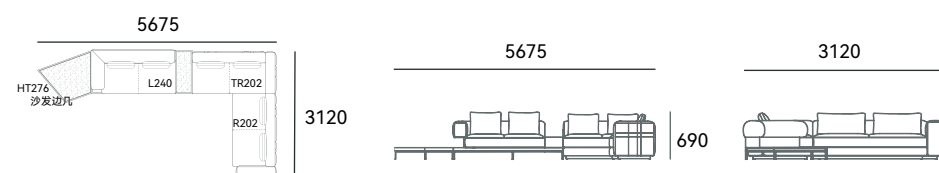

在数学几何的无限可能中，我们深入探索精确而富有张力的形状与比例，力求打造出和谐且独特的形态。几何沙发以直线和块面构成，展现出均衡的美感。通过简单的几何形状，形成富有节奏感的设计，成为空间中的视觉焦点。整体设计注重视觉冲击力与舒适性的结合，旨在为现代家居空间增添一抹艺术气息。

In the infinite possibilities of mathematical geometry, we deeply explore precise and tense shapes and proportions, striving to create a harmonious and unique form. The geometric sofa is composed of straight lines and blocks, showing a balanced beauty. Through simple geometric shapes, a rhythmic design is formed, becoming the visual focus in the space. The overall design focuses on the combination of visual impact and comfort, aiming to add a touch of art to the modern home space.



沙发设计可拆分或组合的模块，边几既可以作为沙发的链接部分，起到装饰和收纳作用，又可以独立存在，作为茶几摆放，适应多种空间需求。

The sofa is designed as a module that can be split or combined. The side table can be used as a link part of the sofa for decoration and storage, or it can exist independently and be placed as a coffee table to adapt to a variety of space needs.





OPERA 戏剧

摩登优雅一直是法式风格的代名词，织物与皮面的组合，搭配金属立脚挺拔而有型，给千篇一律的设计，注入更多的可能性，演绎一段浪漫华丽的歌剧，将法式情调与当代生活美学，恰到好处地融合。

French style has long been associated with modern elegance. The fusion of fabric, leather, and metal feet exudes a sleek and stylish charm, blending French sentiment with contemporary life aesthetics.

编号: HT268 沙发

主材: 内架多层实木板、不锈钢、A3 钢

尺寸: 4100*1800*780H (mm)

Model: HT268 Sofa

Main material: Solid wood, Stainless steel, level of steel

Size: 4100*1800*780H (mm)

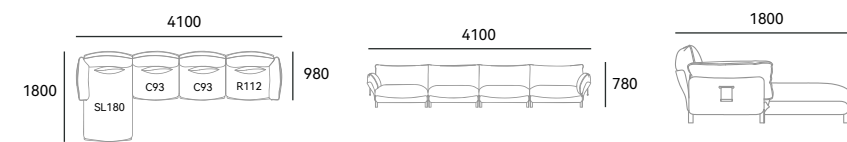





TOAST 吐司

一款手感柔软的吐司沙发，宽厚的扶手营造舒适温馨的氛围，感受如家人般自然流露的关切与温暖，面料手感柔软。饱满立体的造型，让整个沙发趣味不单调，扶手的软包固定在一个金属扣子上，既能保持扶手的造型稳定，也是设计中的点睛之笔。

The tusi sofa with soft fabric and wide armrests to create a cozy and welcoming ambiance reminiscent of family warmth. The three-dimensional shape adds visual interest, while the stable armrest design enhances both form and function.

编号: HT238 沙发

主材: 内架多层实木板、不锈钢

尺寸: 2880*1010*790H (mm)

Model: HT238 Sofa

Main material: Solid wood, Stainless steel

Size: 2880*1010*790H (mm)

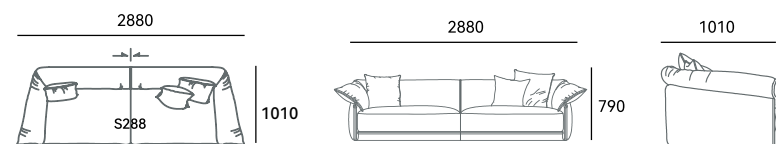







GENTLEMAN 绅士

强调高度的舒适性和温馨怡人的居家氛围。同色系的沙发面料搭配和定制金属配件的细节点缀，以一种深沉静默的方式，展现优雅的概念，如同一位安全感十足的绅士，克制而内敛，低调而百搭。

Highlighting a strong focus on comfort and a welcoming home ambiance. Coordinating sofa fabrics and personalized metal accessories exude an understated elegance, akin to a secure, restrained, versatile gentleman.

编号: HT266 沙发

主材: 内架多层实木板、不锈钢、A3 钢

尺寸: 2870*1030*800H (mm)

Model: HT266 Sofa

Main material: Solid wood, Stainless steel, Level of steel

Size: 2870*1030*800H (mm)

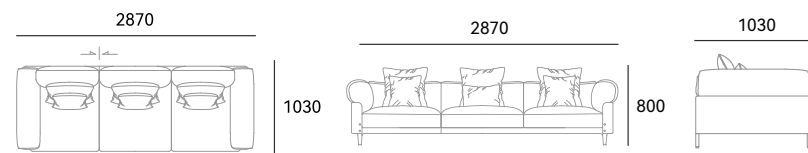



GLASSES AI 眼镜

编号: HT239 沙发
主材: 内架实木、内架多层实木板
尺寸: 1800*1020*650H (mm)

Model: HT239 Sofa
Main material: Solid wood
Size: 1800*1020*650H (mm)

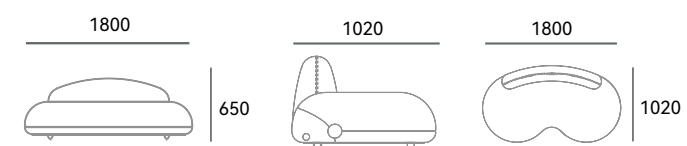

CAKE 蛋糕

编号: HT269 沙发

主材: 内架实木、内架多层实木板

尺寸: 3000*1050*690H (mm)

Model: HT269 Sofa

Main material: Solid wood

Size: 3000*1050*690H (mm)

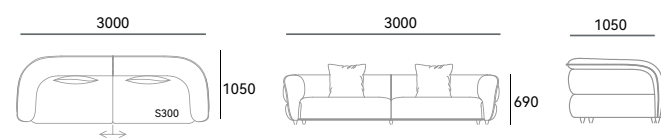





STARTFISH 派大星

编号: HT267 沙发
主材: 实木框架、A3 钢、不锈钢
尺寸: 2250*950*1030H (mm)

Model: HT267 Sofa
Main material: Solid wood, Level of steel, Stainless steel
Size: 2250*950*1030H (mm)

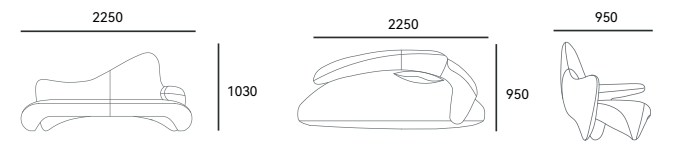

BURGER 汉堡

编号: HT216 大坐墩

主材: 不锈钢、多层实木板

尺寸: 880*880*440H (mm)

Model: HT216 Sofa

Main material: Stainless steel, Solid wood

Size: 880*880*440H (mm)

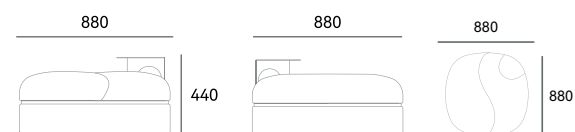

TOAST SLICES 吐司片

编号: HT261 沙发

主材: 内架实木、内架实木多层板、桦木

尺寸: 2880*1020*630H (mm)

Model: HT261 Sofa

Main material: Solid wood

Size: 2880*1020*630H (mm)



AIRCHAIR

休闲椅



少数派从未定义风格,在嘈杂的世界里保持赤子之心,保持对这个世界的探索和创造力,以俏皮幽默的玩趣风格,新锐独特的审美感知,诠释少数派的独有美学和不拘一格的自由精神。

The minority has never defined a style. It maintains its innocence in a noisy world, maintains exploration and creativity of the world, and interprets the minority's unique aesthetics and informality with a playful and humorous style and cutting-edge unique aesthetic perception. A free spirit.



PUPPY

狗狗

编号: HT232 休闲椅

主材: 内架实木、内架多层实木板

尺寸: 720*720*750H (mm)

—

Model: HT232 Armchair

Main material: Solid wood

Size: 720*720*750H(mm)

这只温柔而有趣的狗狗椅，外形酷似汪星人，圆润柔和的曲线设计，具有可爱的矮胖感，追求形体的优雅和自然的舒适感，给人满满的温暖和安全感。舒适、优雅、趣味、精湛的工艺是TA的关键词，追求形体的优雅和自然的舒适度，给人满满的温暖和安全感。

This unique doggy chair has a gentle and intriguing design, resembling dog with its soft, round curves. It exudes a cute, pleasantly plump appeal and is all about achieving physical elegance and natural comfort. It delivers a compelling sense of warmth and security, showcasing comfort, elegance, and exquisite craftsmanship as its defining qualities.

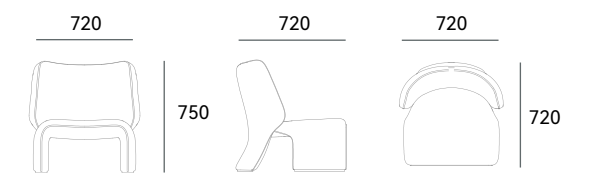

SEMIQUAVER

音符

编号: HT228 休闲椅

主材: A3 钢、内架多层实木板、不锈钢

尺寸: 780*710*700H (mm)

Model: HT228 Armchair

Main material: level of steel, Solid wood, Stainless steel

Size: 780*710*700H (mm)

灵感来自于音符造型，采用简而含蓄的设计语言，将坐的体验最大程度地舒适化，这款音符休闲椅有着圆润饱满的造型，宽阔厚实的扶手连接着靠背，并围绕住整个座椅，给予使用者强烈的包裹感。

Taking inspiration from musical notes, the Semiquaver lounge chair features a simple and subtle design aimed at maximizing sitting comfort. Its rounded shape, wide armrests, and enveloping feel create a pleasant user experience.

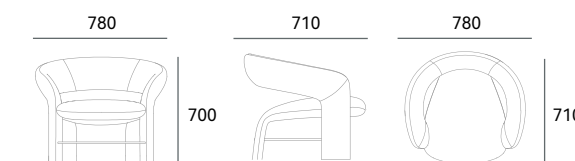

ARC

弧形

编号: HT227 休闲椅

主材: 内架实木、内架多层实木板、不锈钢

尺寸: 800*650*880H (mm)

Model: HT227 Armchair

Main material: Solid wood, Stainless steel

Size: 800*650*880H(mm)

天然去雕饰的至简美学，造型柔和圆润，线条流畅婉转，勾勒出温婉亲密的格调，造型虽然简单，却有着超乎想象的舒适度与功能性，温润的色调与端庄大方的造型完美融洽，精简有序，安静沉稳，柔和含蓄，独享闲暇，自在静谧。

The simple, smooth lines and soft shapes of natural carving embody a minimalist and intimate style, offering unparalleled comfort and functionality. The warm tones and dignified, generous form perfectly harmonize, evoking a sense of tranquility and calmness for exclusive leisure and relaxation.

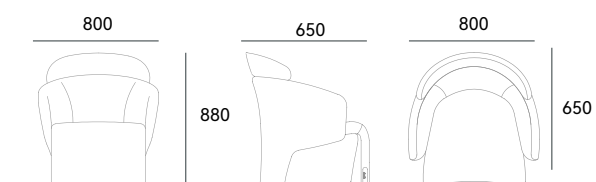



VENUS

维纳斯

编号: HT252 休闲椅

主材: 玻璃钢、不锈钢

尺寸: 940*990*940H (mm)

—

Model: HT252 Armchair

Main material: FRP, Stainless steel

Size: 940*990*940H (mm)

灵感源自波提切利《维纳斯的诞生》，HOTHING 将贝壳作为设计元素，以内敛的流线造型，打造直观的戏剧感和艺术感，勾勒出属于这个时代的生活方式，将性感、优雅、复古、现代融为一体，兼具独立与优雅高级的美。

Inspired by Botticelli's "The Birth of Venus", HOTHING uses the shell as a design element to blend a restrained streamlined shape with a dramatic and artistic flair that embodies the lifestyle of the era. It seamlessly integrates sexiness, elegance, retro, and modernity, exuding an independent and elegant high-end beauty.

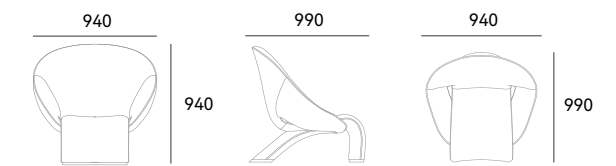

扶手椅采用整体流线型设计，像一件精致的艺术品般展现在眼前。椅背和座椅部分呈现出贝壳般的优雅曲线，营造出脱俗飘逸的视觉感受。整体造型犹如一尊维纳斯女神般的艺术雕塑，彰显出高雅迷人的气质。

The armchair adopts an overall streamlined design, unfolding before your eyes like an exquisite work of art. The chair back and seat show elegant shell-like curves, creating a refined and elegant visual experience. The overall shape is like an artistic sculpture like the goddess Venus, showing its elegant and charming temperament.



TERRA

大地

编号: HT230 休闲椅

主材: 内架实木、内架多层实木板、不锈钢

尺寸: 750*800*940H (mm)

Model: HT230 Armchair

Main material: Solid wood, Stainless steel

Size: 750*800*940H(mm)

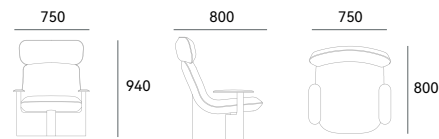

大地休闲椅是一个适合“停下来”的自处空间，宽阔低矮的扶手，不仅可以手臂的放置更加惬意，更让整张扶手椅重心压低，给人厚重沉稳的踏实感。坐在上面，可以放空、可以冥想、可以小憩，像一位默契十足的老友，以最舒服的姿态静静陪伴。

The Terra armchair provides a cozy, low-armed space that enhances comfort and stability, perfect for relaxation, meditation, or napping. It offers a sense of security and understanding, like a loyal companion quietly supporting your comfort.

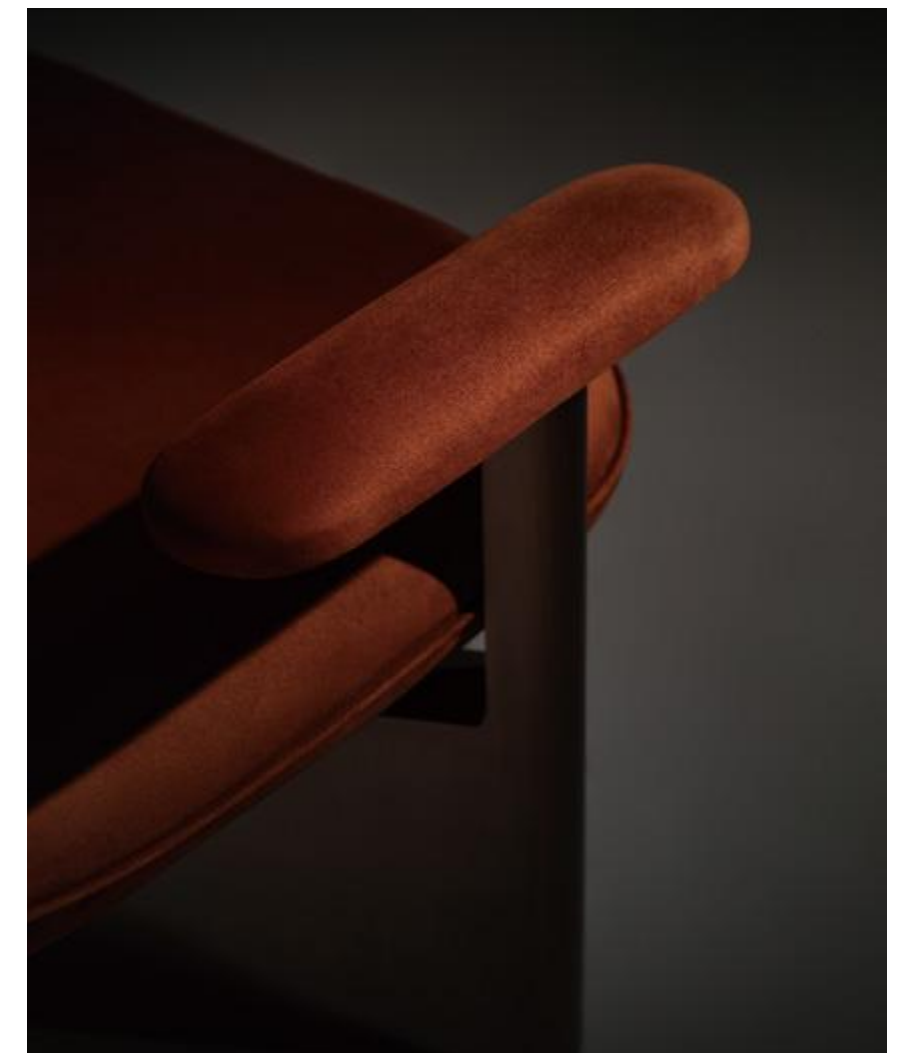

ROSE

玫瑰

编号: HT269 休闲椅

主材: 内架多层实木板

尺寸: 850*870*960H (mm)

—

Model: HT269 Armchair

Main material: Solid wood

Size: 850*870*960H(mm)

真正的少数派，是知道生活的真相之后，依然热爱生活，一款灵感来自“心有猛虎，细嗅蔷薇”的玫瑰椅，致敬敢于不同的少数派。玫瑰椅棱角分明却温和，极显建筑分量感，通过不同的模块组合，碰撞出不羁的意趣，特立独行，与众不同。

The true minority are those who continue to love life despite knowing its truth. The Rose Chair, inspired by "a tiger in the heart, smelling the rose," honors those who dare to stand out. With its gentle yet strong architectural design, the chair's sharp edges create an uninhibited and unique interest through a combination of different modules.

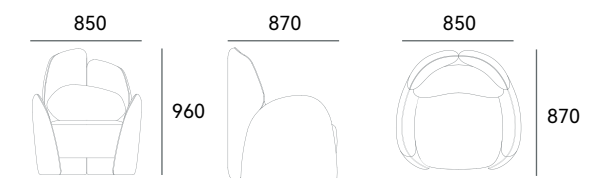

SHELL

贝壳

编号: HT268 休闲椅

主材: 内架实木、内架多层实木板

尺寸: 700*810*720H (mm)

Model: HT268 Armchair

Main material: Solid wood

Size: 700*810*720H (mm)

每个贝壳都有一种神秘的能量，传递着爱、希望和无尽的祝福。SHELL 椅由两片贝壳组成的生动造型，采用流线型设计，营造温润、自然的视觉效果，呈现出贝壳的优美曲线，立体又轻盈，具有独特的建筑美感，在任何空间都可以大胆表达。一张懂你的椅子，让忙碌的生活暂时止步。

The SHELL chair features two vividly shaped shells with streamlined design, creating a warm and natural visual effect. It showcases the graceful curve of a shell, offering a unique architectural beauty that boldly stands out in any space. This chair understands you and provides a brief pause in your busy life.

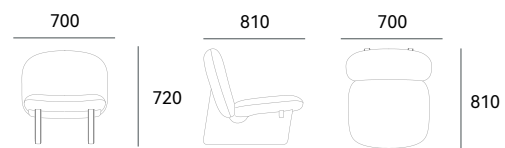



MUSE

缪斯

编号: HT253 休闲椅

主材: 内架多层实木板、不锈钢

尺寸: 650*720*760H (mm)

—

Model: HT253 Armchair

Main material: Solid wood, Stainless steel

Size: 650*720*760H(mm)

凭借着蓬松的“发量”，缪斯休闲椅远看如同一只毛绒绒的小羊羔，纤细的金属与极度柔软舒适的羊毛靠背，软萌可爱的造型与摇滚气质碰撞，打破厚重，轻奢时髦又轻盈简洁，放在任何环境中都能成为焦点脱颖而出。

The Muse leisure chair resembles a fluffy lamb with its voluminous "hair" and features a slender metal frame with an extremely soft, comfortable wool backrest. Its soft and cute design juxtaposes with a rock and roll temperament, giving off a luxurious, fashionable, light, and simple vibe that captures attention in any setting.

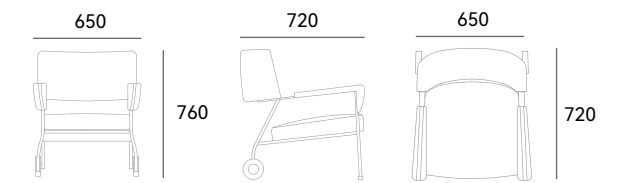



BABY

小屁孩

编号: HT260k 休闲椅

主材: 玻璃钢、不锈钢

尺寸: 730*730*720H (mm)

Model: HT260k Armchair

Main material: FRP, Stainless steel

Size: 730*730*720H(mm)



·麒麟 ART 艺术馆永久收藏作品
·荣获 GOLDEN PIN DESIGN AWARD
2022 金点设计奖

如果世界过于正统和现实，便失去了乐趣，这是一件充满治愈力量的作品，而驾驭一切的，是玩心。BB Chair 的设计灵感来源于 A Little baby's butt。设计师和他的孩子在海边玩耍，小孩子撅着屁股玩沙子的可爱模样，化作设计灵感想象，我们希望通过这件作品去唤醒人们内心的童真和快乐，送给每一个童心未泯的你！

The little-Boy Chair is inspired by the adorable pouting and playing of children on the beach, reflecting innocence and happiness. This design aims to awaken the inner child in everyone.

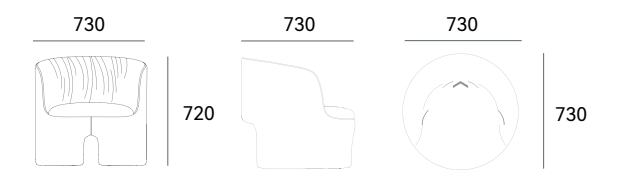



以呆萌、可爱为设计理念，赋予产品天真童趣的特点；运用曲线、曲面结合人体工学，充分展现休闲、舒适特性；整体造型敦厚饱满，给人满满的安全感。

This chair is designed with the concept of naivete and cuteness, giving the product the characteristics of innocence and childlikeness; The use of curves, curved surfaces combined with ergonomics, fully show the characteristics of leisure and comfort; The overall shape is thick and full, giving people a full sense of security.



FUSION

融

编号: HT261 休闲椅

主材: 玻璃钢、内架多层实木板

尺寸: 680*870*800H (mm)

Model: HT261 Armchair

Main material: FRP, Solid wood

Size: 680*870*800H(mm)

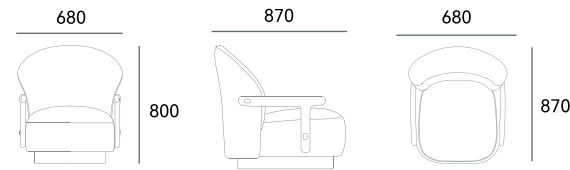

在设计师重新思考东方家具在当代生活方式中的改变时，一款开创性的休闲椅「融」应运而生。它的灵感源于明清圈椅，既保留了传统的典雅线条和韵味，同时又突破传统意义，通过现代的材质和工艺赋予其时尚的观感与舒适的体验。简约的设计，宽阔的座面融合了中国传统座椅的庄重与包豪斯极简风格的现代感，适合追求时尚与舒适并重的用户群体。

As designers rethink the Oriental furniture's role in modern living, the groundbreaking Fusion leisure chair takes inspiration from Ming and Qing Dynasty armchairs. It retains elegance and charm while incorporating modern materials and craftsmanship for a fashionable and comfortable experience. The simple design and spacious seating area merge traditional Chinese chair solemnity with Bauhaus minimalist modernity, appealing to those who seek both fashion and comfort.



LILIUM

百合

编号: HT263 休闲椅

主材: 玻璃钢、不锈钢

尺寸: 830*830*740H (mm)

—

Model: HT263 Armchair

Main material: FRP, Stainless steel

Size: 830*830*740H(mm)

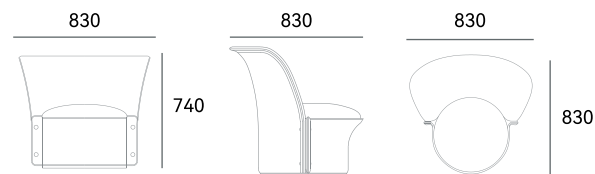

灵感来自百合花瓣的曲线设计，柔美、流畅的线条，仿佛坐在百合花瓣上一般舒适，勾勒出随性的生活姿态。整体造型流畅自然，比例匀称美观，既彰显了百合花的优雅风范，又符合人体工学设计，提供舒适的坐姿。作为家居装饰的精致之选，它不仅提供了舒适的休息场所，更为家居空间增添了一抹优雅与浪漫的氛围。愿它如同一朵百合花般，为您带来清新、高雅的生活体验。

Taking inspiration from the curved design of lily petals, the soft and smooth lines of the chair provide comfortable and ergonomic sitting. Its overall shape is elegant and natural, adding an exquisite and romantic atmosphere to home decor. Embrace a fresh and elegant life experience reminiscent of the grace of a lily.



作为家居装饰的精致之选，它不仅提供了舒适的休息场所，更为家居空间增添了一抹优雅与浪漫的氛围。愿它如同一朵百合花般，为您带来清新、高雅的生活体验。

This stylish home accessory offers both comfort and an element of elegance and romance to any living space. Like a lily, it brings a fresh and refined living experience.

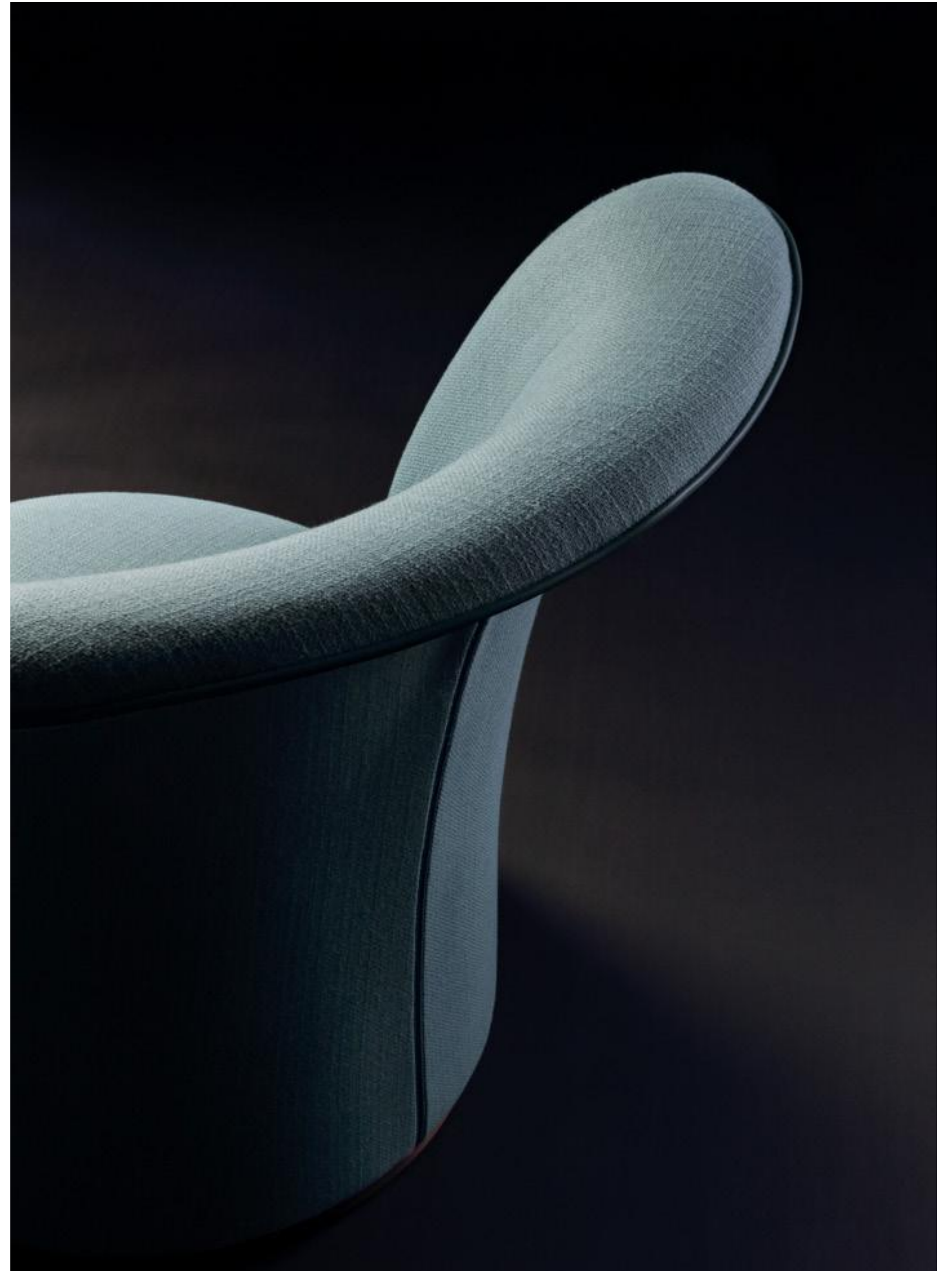

MODERN

摩登

编号: HT267 休闲椅

主材: 内架实木、不锈钢

尺寸: 830*910*980H (mm)

Model: HT267 Armchair

Main material: Solid wood, Stainless

steelSize:830*910*980H(mm)

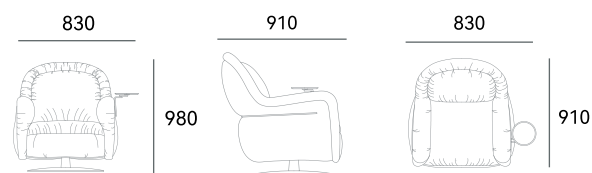

摩登休闲椅不仅仅是舒适的休息之所，更是展示个性和品味的绝佳选择，从现代摩登到复古风，无论是热衷舒适感还是钟情于格调，都能满足你对椅子风格的所有需求。椅子的整体设计以稳重、大气为主，它并非仅仅家具，也是气度，是陪伴。

A modern lounge chair offers both comfort and a reflection of your personality and style, whether you prefer a modern or vintage look. It provides stability and character, serving as both furniture and a companion.



INTERSTELLAR

星际系列

编号: HT270 休闲椅

主材: 玻璃钢

尺寸: 730*850*820H (mm)

—

Model: HT270 Armchair

Main material: FRP

Size: 730*850*820H(mm)

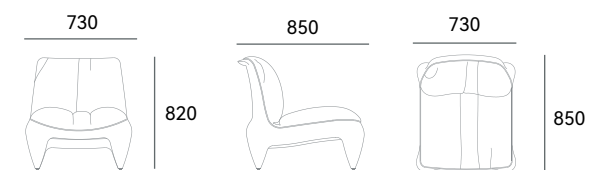

以巨甲虫结构为灵感，饱满腿部如同性感肌肉线条，打造出流畅而富有动感的外形，同时充盈饱满坐垫和靠背，带来及其柔软舒适的体验。一半刚，一半柔的混搭风格，为家居带来先锋艺术感，它将成为任何休闲空间中的亮点，为人们带来舒适、优雅和艺术的享受。

Taking inspiration from the structure of a giant beetle, the sleek legs define a dynamic appearance, while the soft seat cushion and backrest offer a comfortable experience. This blend of rigid and soft elements creates an avant-garde artistic feel, adding comfort, elegance, and artistic enjoyment to any leisure space.



休闲椅座椅采用无扶手设计，玻璃钢一体成型腿脚饱满且极具先锋感；独立研发仿金属漆，具有斑驳的艺术感；羽绒填充让休闲椅极具舒适性。

The leisure chair seat adopts an armless design, and the fiberglass one-piece molded legs and feet are full and avant-garde. The imitation metal paint is independently developed and has a mottled artistic feel. The down filling makes the leisure chair extremely comfortable.



MIRÓ

米罗

编号: HT259 扶手椅

主材: 不锈钢、玻璃钢

尺寸: 600*550*720H (mm)

—

Model: HT259 Armchairs

Main material: Stainless steel, FRP

Size: 600*550*720H(mm)

Miró 不是一款传统意义上的休闲椅，更像是一件艺术品，一种敢于不同的少数派精神。它的灵感来自于画家胡安·米罗的作品，以建筑感极强的造型为特点，融合了现代科技与艺术美学，展现出独特的未来感。大胆采用经典红黄蓝三原色碰撞，表达了鲜明且先锋的设计精神。

Miró is more than just a lounge chair - it's a daring work of art inspired by sculptor Joan Miró blending modern technology and artistic aesthetics to evoke a unique sense of the future. Its bold use of primary colors exudes a distinct avant-garde design spirit.

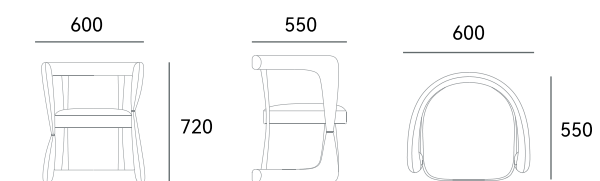

CLOUD

绵绵云朵

编号: HT276 休闲椅

主材: 内架多层实木、不锈钢

尺寸: 840*980*880H (mm)

Model: HT276 Armchair

Main material: Solid wood, Stainless

steelSize: 840*980*880H (mm)

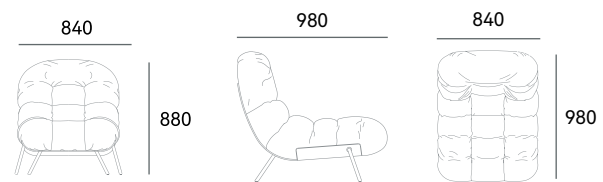

休闲椅的设计类似于云朵的温暖和蓬松, 提供柔软而诱人的体验, 唤起了无重感和宁静感。它是一个放松的避风港, 也是一个温馨的拥抱, 融合了舒适和时尚的精髓。

The lounge chair is designed to resemble the warmth and fluffiness of clouds, offering a soft and inviting experience, evoking a sense of weightlessness and serenity. It provides a haven of relaxation and blends comfort with style.



MODERN 微笑

编号: HT272 休闲椅

主材: 内架实木、内架多层实木板、不锈钢、A3 钢

尺寸: 920*810*690H (mm)

—

Model: HT272 Armchair

Main material: Solid wood, Stainless steel, level of steel

Size: 920*810*690H(mm)

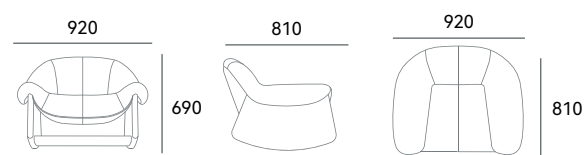

一把温暖的微笑椅，容纳所有舒适、自在的姿态。犹如微笑的弧线造型自带天然的亲近感，窝在其中惬意摇摆，感受饱满座包带来的温暖感，圆弧靠背让包容力和治愈力得到提升，油然而生一种闲适与安心，金属扣的点缀更添活泼，构成一个疗愈身心的小角落，躺在其中，静待幸福来敲门。

The smile-shaped chair provides a cozy and inclusive seating experience. Its warm arc design promotes relaxation and a natural sense of intimacy. The full seat and curved backrest offer comfort and support, creating a space for healing and peaceful moments. The addition of metal buckles adds a playful touch, creating a serene spot to unwind and embrace happiness.





BASSINET

摇篮

编号: HT238 休闲椅

主材: 玻璃钢、A3 钢

尺寸: 800*880*880H (mm)

Model: HT238 Armchair

Main material: FRP, level of steel

Size: 800*880*880H(mm)

一款在家也能玩旋转木马的单人位沙发，卸下盔甲，拾起童真，躺在上面，什么也不想望着天花板 360° 旋转，整体设计贴合身体曲线，在保证支撑性的同时包裹感更强，底座可以 360 度旋转，重回孩提时代感受家的惬意。

A one-seater sofa that doubles as a carousel for your home. Take off your stress, embrace your inner child, recline, and effortlessly rotate 360°. The ergonomically designed seat ensures support and comfort by hugging the body's curves. Its swiveling base allows you to relive the carefree feeling of childhood and experience the homey comfort it brings.

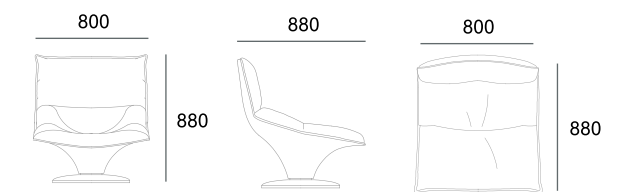

BIG BIG

胖墩

编号: HT266 休闲椅

主材: 玻璃钢、不锈钢

尺寸: 860*1020*950H (mm)

640*540*430H (mm)

Model: HT266 Armchair

Main material: FRP, Stainless steel

Size: 860*1020*950H(mm)

640*540*430H (mm)

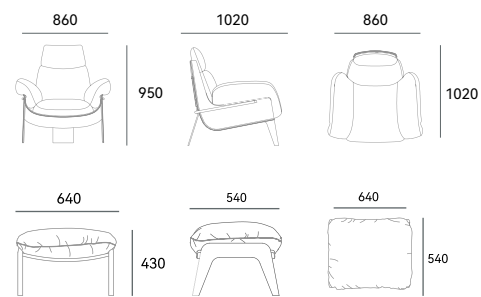

胖墩休闲椅采用了圆润的线条和简洁的造型, 使其看起来非常可爱和亲切, 坐面宽阔厚实, 陷入感十足, 软糯的坐感给身体充分放松和满满的安全感, 以最平凡的姿态, 包容所有姿态, 打造百搭舒适的空间。

The stout leisure chair features sleek rounded lines and a simple, inviting design, exuding a friendly and endearing aesthetic. Its spacious and cushy seat enhances relaxation and a sense of security, accommodating various postures and creating a versatile and comfortable space.

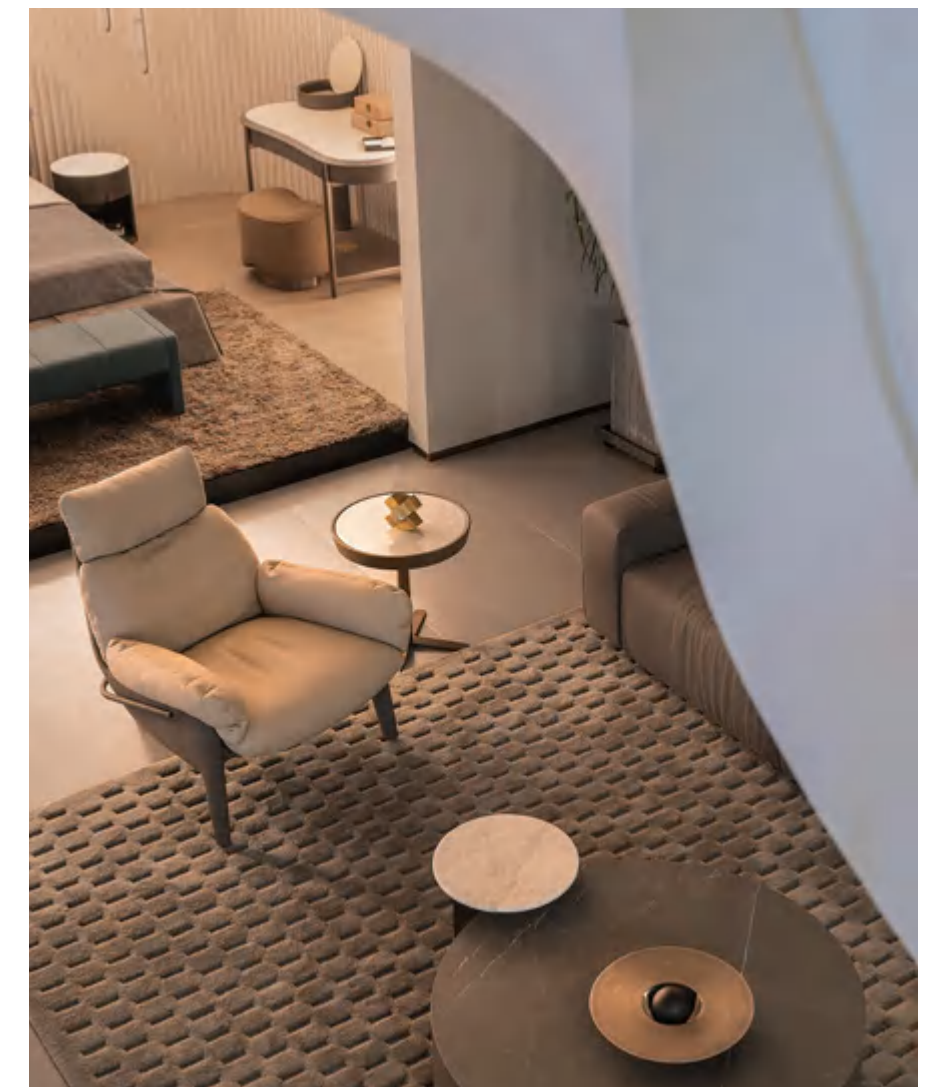

FLOWER

花瓣

编号: HT237 休闲椅

主材: 内架多层实木板、不锈钢

尺寸: 730*930*830H (mm)

—

Model: HT237 Armchair

Main material: Solid wood, Stainless steel

Size: 730*930*830H(mm)

写意的线条自由弯曲延伸，来自花瓣的灵感，简洁的线条完美的贴合人体身躯，赋新当代语境下的极简肆意，雕塑感、曲线感以及色彩的鲜明，是作品的主要特征，宛如一抹暖阳明媚亮眼，不论放在哪个角落，都可以惊艳整个空间。

The freeform lines, reminiscent of flower petals, effortlessly bend and extend. These simple lines elegantly complement the human form, exuding minimalist allure in a modern context. Sculptural in essence, with curves and vibrant colors as its defining characteristics, the work emanates a warmth and brightness that can captivate any space.

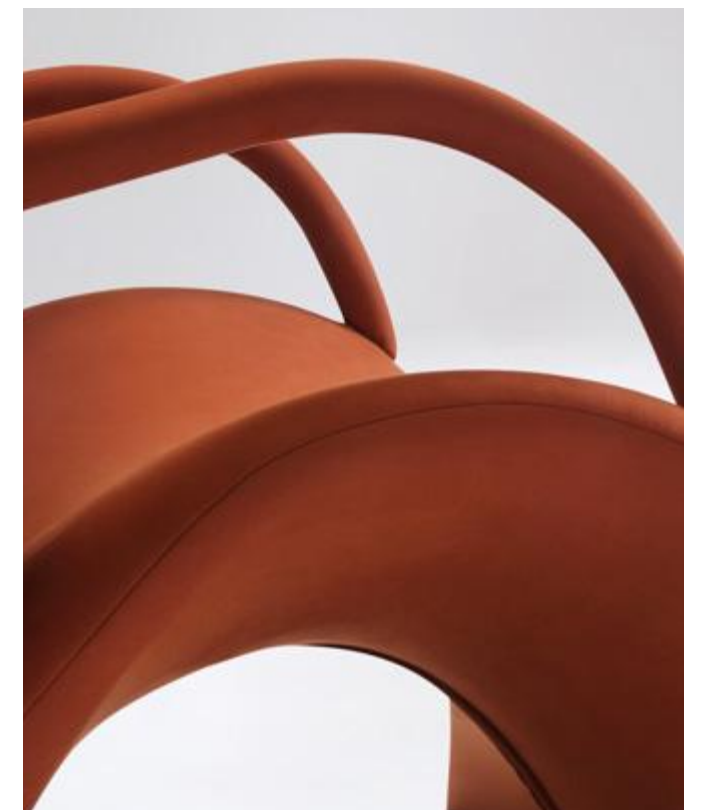
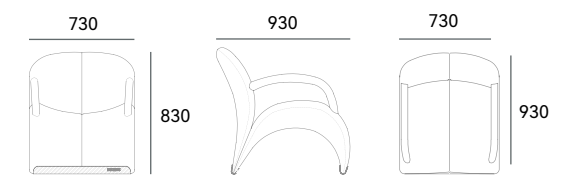

SPACE

太空

编号: HT239 休闲椅

主材: 内架实木、内架多层实木板、不锈钢

尺寸: 930*950*725H (mm)

Model: HT239 Armchair

Main material: Solid wood, Stainless steel

Size: 930*950*725H(mm)

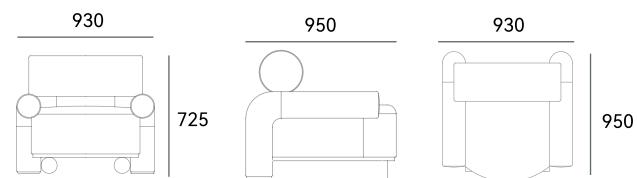

设计灵感源于中国自主研发的空间站事业，从浩瀚的宇宙视角审视人类自身，以阔大的宇宙视野，炽热的谦卑之心，带来一场科学的世界观与价值观。TA 介于家具和建筑之间，曲线的家族设计语言贯穿于家具的设计表现，呼应星际间的星体运行轨迹，以天生无畏去探索这个时代。

The design takes inspiration from the Chinese space station to explore the human perspective within the universe. It blurs the lines between furniture and architecture, integrating curved shapes to echo the interstellar movement of stars and embrace the era with boldness.



CINEMA

影院

编号: HT258 休闲椅

主材: A3 钢、内架多层实木板、不锈钢

尺寸: 750*850*860H (mm)

Model: HT258 Armchair

Main material: level of steel, Solid wood, Stainless steel

Size: 750*850*860H(mm)

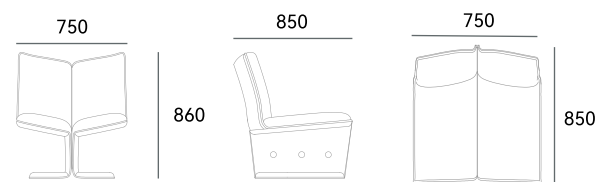

影院休闲椅巧妙的对称和大胆创新的造型，成为最引人瞩目的独特之点，赋予坐感一种崭新体验，椅身如书页般徐徐地展开，形似影院中相互依偎的二人坐席。简单轻松的折叠感和整体造型，传递出优雅姿态的同时，又充满张力的体验。

The Cinema lounge chair is distinguished by its clever symmetry and bold shape that offer a new and unique sitting experience. Its easy folding and elegant posture create a captivating and comfortable seating option, resembling two people nestled in a cinema.



COFFEE TABLE

茶几

PUZZLE

拼图

编号: HT265 组合几

主材: 石材、HDF 高密度板

尺寸: 1000*450*220 (mm)& 1000*840*285 (mm)
& 580*693*320 (mm)

Model: HT265 coffee table

Main material: Marble, HDF

Size: 1000*450*220 (mm)& 1000*840*285 (mm)
& 580*693*320 (mm)

一款来自拼图游戏的灵感想象，拼图茶几以简洁利落的线条，打破单一物体的局限性，搭配灵活多变的造型，让家居生活充满几何魅力，带来更多值得玩味的使用场景，创造藏而不露的空间哲学，同时使用者也能根据自己的爱好，调整设计茶几的组合方式，十分有趣。

The jigsaw puzzle coffee table, inspired by imaginative design, transcends the constraints of a singular object with its sleek and adaptable lines. It introduces geometric charm to home life, offering diverse usage scenarios and encouraging a philosophy of hidden space. Users can customize the table's design based on personal preferences, adding an element of fun and intrigue.

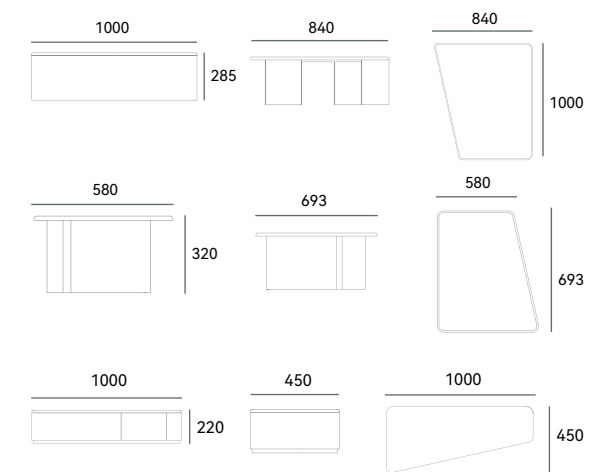

THE WIZARD OF OZ

绿野仙踪

编号: HT273 组合几

主材: 石材、玻璃钢、不锈钢、HDF 高密度板

尺寸: 1750*1050*320 (mm) & ϕ 600*450 (mm)

Model: HT273 Coffee table

Main material: Marble, FRP, Stainless steel, HDF

Size: 1750*1050*320 (mm) & ϕ 600*450 (mm)

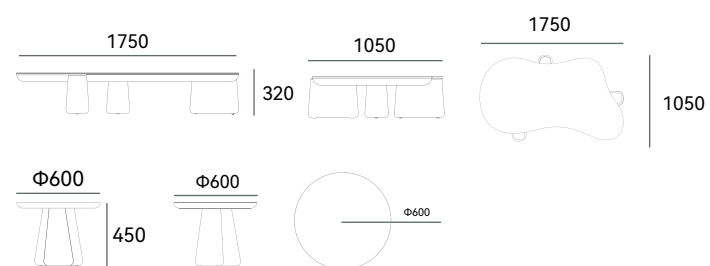

“绿野幽光，盈满晨曦”，像闯进了雷诺阿笔下的绿野仙踪，如同童话的秘境般的幽静的梦幻，绿色的天然奢石，让人放松，在这个作品里，你能感受到自然带给你的能量。主茶几的造型灵感来自树木的年轮，不规则的曲线流动，营造不羁的生命态度，而小茶几则呈现出童趣与可爱，为空间增添了一份生动与趣味。

The lush green field bathed in morning light resembles stepping into Renoir's version of the Wizard of Oz. It exudes a tranquil, fairy-tale-like ambiance, inducing relaxation with its luxurious green marbles. The design draws inspiration from nature's energy, evident in the main coffee table's tree growth ring-inspired curves and the whimsical charm of the smaller table. Encouraging individuality, the design advocates defining a personal lifestyle amidst worldly trends.



ART DECO 装饰艺术

编号: HT276 组合几

主材: 石材、HDF 高密度板、染色白橡木皮、不锈钢、玻璃

尺寸: $\Phi 1100 \times 320$ (mm) & $\Phi 700 \times 280$ (mm)

—

Model: HT276 Coffee table

Main material: Marble, HDF, Stainless steel, Glass

Size: $\Phi 1100 \times 320$ (mm) & $\Phi 700 \times 280$ (mm)

茶几的灵感来自 Art Deco 装饰艺术革命的灵感, 强调奢华的风格和对色彩、几何形状的丰富应用, 强调流畅又锐利的线条和自然的图案, 打造出具有实验性的先锋设计作品。这款组合茶几不仅具有艺术性和实用性, 还展现了对当代设计思潮的理解和创新的探索, 将为家居空间带来全新的视觉体验和生活享受。

Drawing inspiration from the Art Deco movement, this luxurious coffee table showcases a rich use of color and geometric shapes, emphasizing smooth lines, sharp angles, and natural patterns. This combination table is both artistic and practical, reflecting an innovative exploration of contemporary design trends, promising a new visual experience and enhanced living space enjoyment.

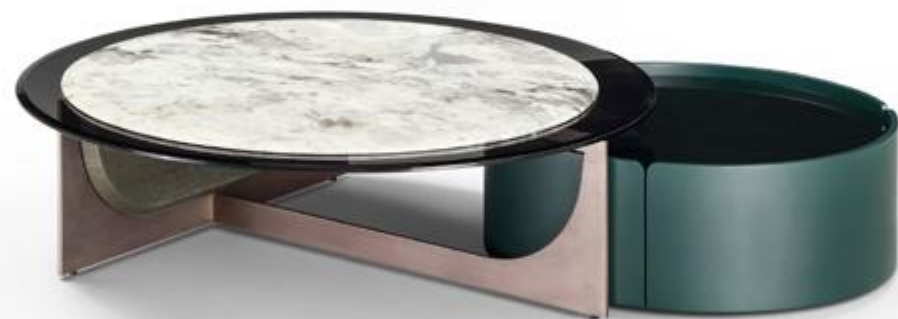
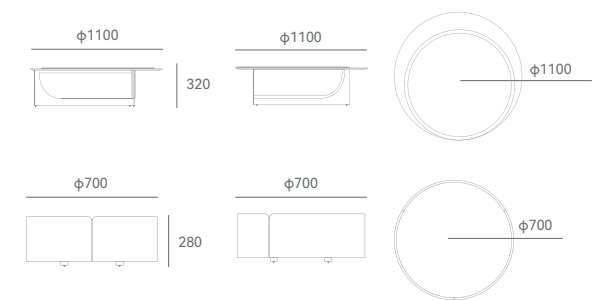

TIE 穿斗

编号: HT262 组合几

主材: 石材、HDF 高密度板、不锈钢

尺寸: 1200*1200*300 (mm) & Φ 600*450 (mm)

Model: HT262 Coffee table

Main material: Marble, HDF, Stainless steel

Size: 1200*1200*300 (mm) & Φ 600*450 (mm)

设计灵感来自于古代建筑中采用的横梁穿过垂直支柱的穿斗形式，以独特的视觉效果和实用性为特点。一套包含大的方形茶几和小的圆形茶几，满足不同空间和需求的摆放和使用。取名为 "Crossbeam Ensemble" 横梁合奏，寓意着传承中国传统文化的永恒精神，以及大气磅礴的气势和高贵典雅的品质。

The design takes inspiration from the Chinese space station to explore the human perspective within the universe. It blurs the lines between furniture and architecture, integrating curved shapes to echo the interstellar movement of stars and embrace the era with boldness.

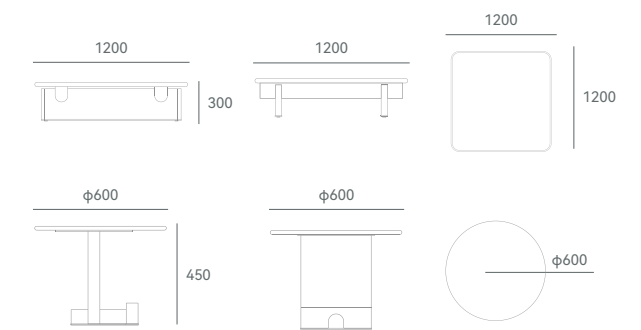

CHAIN

回形针

编号: HT268 圆几

主材: 玻璃、玻璃钢、不锈钢、石材

尺寸: $\Phi 450 \times 440$ (mm)

—

Model: HT268 Coffee table

Main material: Glass, FRP, Stainless steel, Marble

Size: $\Phi 450 \times 440$ (mm)



茶几的底座设计灵感来源于回形针的造型，采用简约的线条和曲面，环环相扣的设计不仅使整体结构稳固而富有动感，更是一种美好的寓意。茶几由多种材质的碰撞组合，增加整体设计的层次感和不被定义的美感，为家居空间增添一份独特的艺术氛围。

The coffee table's base is inspired by the elegant shape of a paper clip, boasting simplicity in its lines and curves. The interlocking design enhances both stability and dynamism, with added depth and beauty through the collision combination of multiple materials. This breathes a unique artistic atmosphere into any home space.

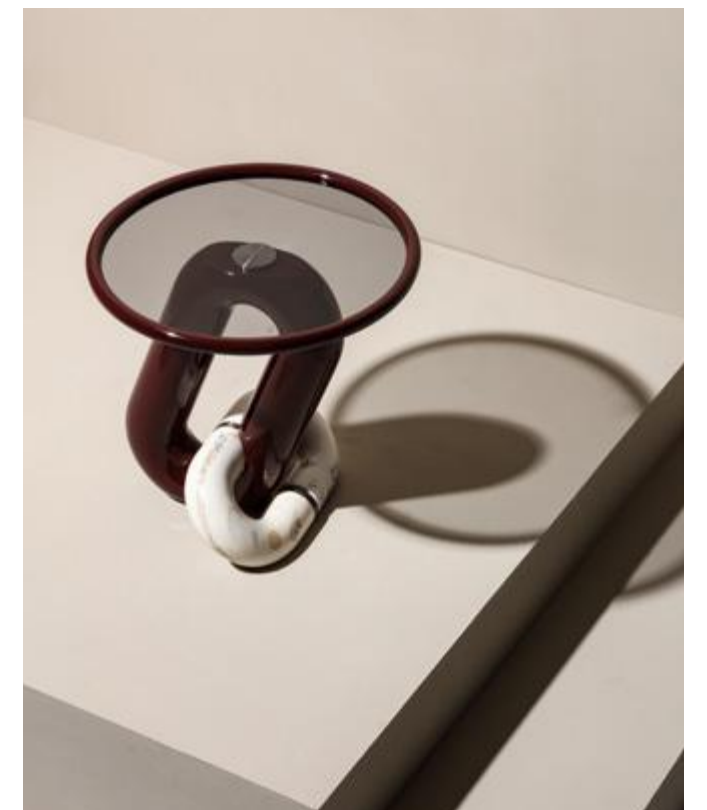

TETRIS

俄罗斯方块

编号: HT228 组合几

主材: 石材、不锈钢

尺寸: 900*900*320H (mm) & 380*380*420H (mm)

Model: HT228 Coffee table

Main material: Marble, Stainless steel

Size: 900*900*320H (mm) & 380*380*420H (mm)



边几台面由整片金属冲压而成，拥有和石材同样的圆润边缘，与茶几一同组合，形成高低错落的丰富形态。茶几石面采用巴西进口奢石喀斯特，纯黑色系加上天然金色纹理走向，犹如一幅宇宙中漫天星系的画面，高雅而不失格调。石质触感厚实，质感强，奢石中蕴藏的结晶体闪烁跳跃。

The side table top is crafted from a single piece of metal with rounded edges, complementing the coffee table to create a varied shape. The coffee table features luxurious Brazilian karst Marble in pure black with a natural golden texture, resembling a galaxy in the universe, exuding elegance and style. The thick and textured Marble is adorned with sparkling crystals, creating a captivating visual effect.

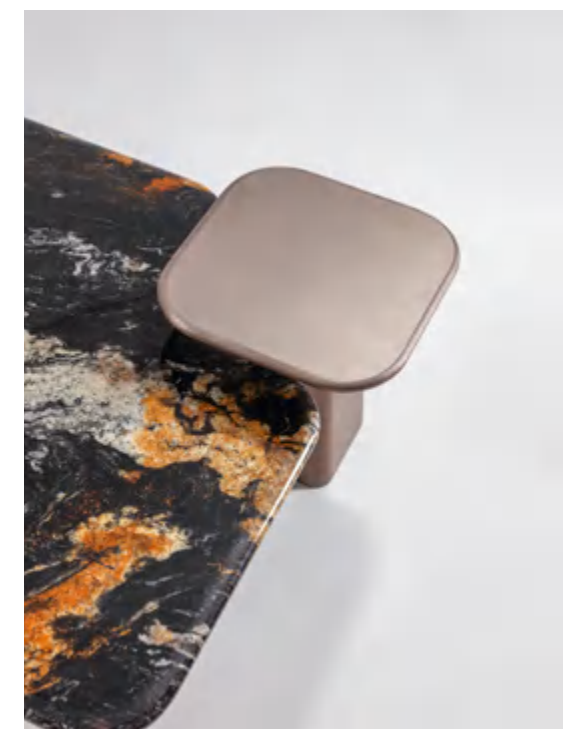
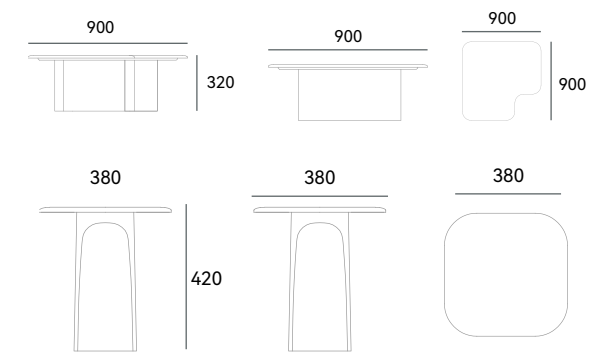

茶几桌面造型如同俄罗斯方块一般经过精确计算，巧妙地组合出更加灵活多变的形式，对不同的空间有着更强的适应性，轻松的组合方式拉伸了茶几的延展性，用户在搭配摆放的过程中，不自觉地参与到了设计中。

The Tetris coffee table mimics the game's shape, offering a flexible and adaptable design that allows for easy customization, engaging users in the process of arranging the table.

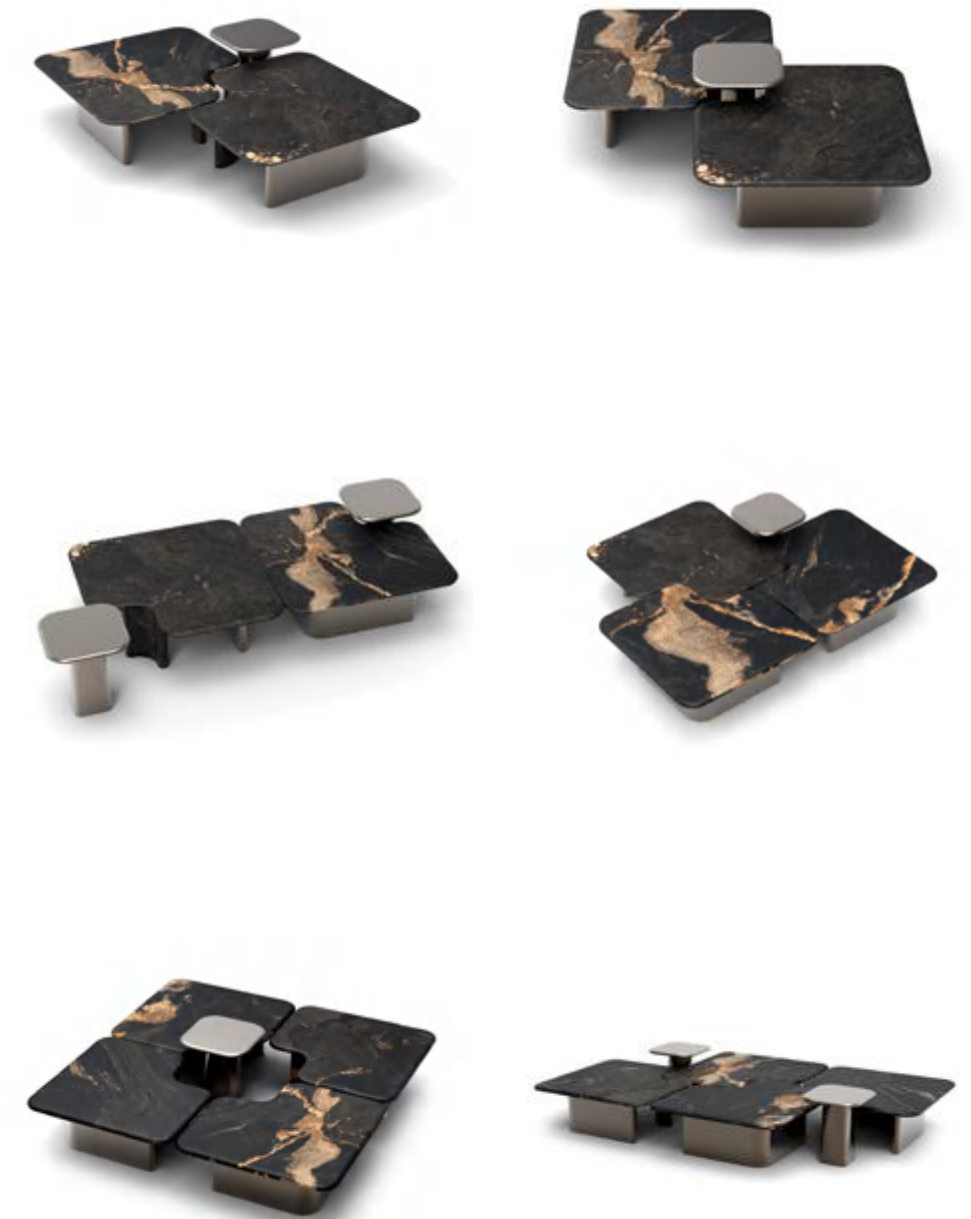
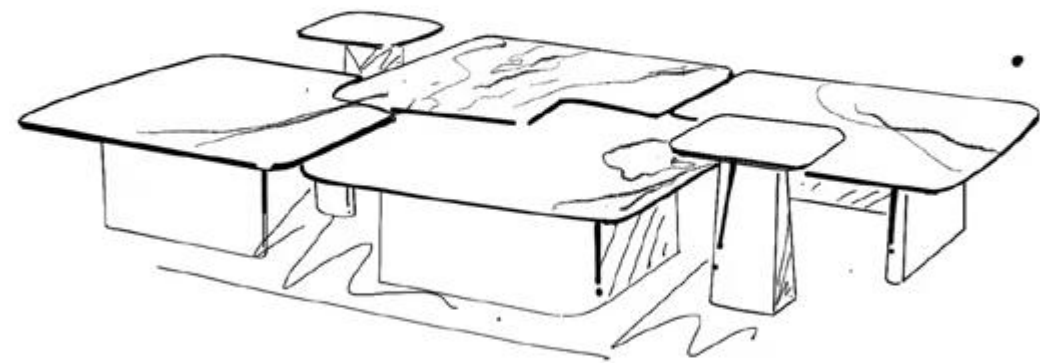

CD 唱片

编号: HT252 方几

主材: HDF 高密度板、染色白橡木皮、玻璃、石材

尺寸: 1100*1100*350H (mm)

—

Model: HT252 Coffee table

Main material: HDF, Wood, Glass, Marble

Size: 1100*1100*350H (mm)

生活的艺术，应当从家开始，重新找回对生活的掌控和热爱，与人和谐和情感共鸣，唱片茶几采用了不同材质的几何体块，堆砌组合而成，中间的玻璃层起到了展示的作用，造型似唱片机似八音盒，可以尽情扩展想象的边界。

The record coffee table is constructed from various stacked geometric blocks of different materials with a central glass display. Its design resembles that of a record player or a music box, allowing for expanded imagination.

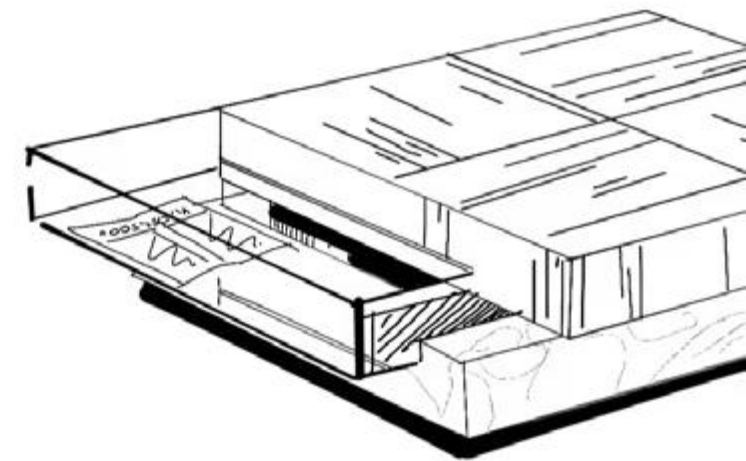
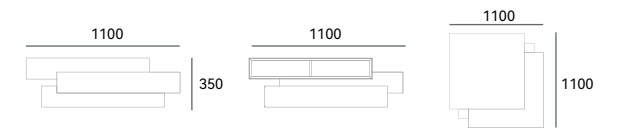



GEOMETR 几何

编号: HT252 角几

主材: 五金、石材、玻璃

尺寸: 320*320*420H (mm)

Model: HT252 Coffee table

Main material: Stainless steel, Marble, Glass

Size: 320*320*420H (mm)



简于形、奢于心，几何角几以多种材质相遇结合，大理石多变的纹理与色彩，玻璃、金属的坚硬与光泽，通过精确的几何形状和的组装配比展现了作品的独创性，保持了清晰的建筑概念，可自由移动，随心置物。

Through the careful juxtaposition of marble textures and colors, and the durability and sheen of glass and metal, the work showcases its originality. It maintains a coherent architectural concept, empowering unrestricted movement and customized placement.

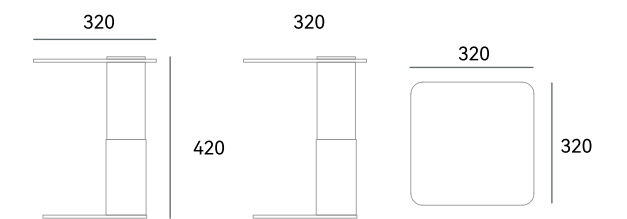

LOTUS

睡莲

编号: HT238 组合几

主材: 石材、不锈钢

尺寸: 1750*1190*360H (mm) & 690*430*420H (mm)

Model: HT238 Coffee table

Main material: Marble, Stainless steel

Size: 1750*1190*360H (mm) & 690*430*420H (mm)

睡莲茶几灵感来自莫奈的后花园，莫奈在吉尼斯的居住地有一片花园和一处池塘，池塘里总会开出许多睡莲，记忆中那一方静谧与灵动，化作少数派的设计语言，奢石天然的质感璀璨，还原记忆中那一方莲池，宛若置身在静谧的花园，流淌着温柔与美好。

The water lily coffee table draws inspiration from Monet's garden in Giverny, where the tranquil pond filled with blooming water lilies inspired its design. The luxurious marble embodies the natural texture of the lotus pond, evoking a sense of calm and beauty reminiscent of the serene garden.

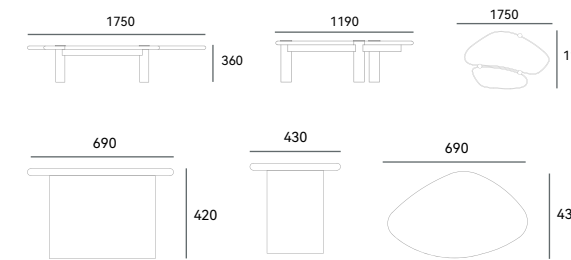

外观灵感来自大小形状不一的莲叶，叠层的组合设计，深浅不一，纹路各异。金属桌腿支撑如同莲叶的枝干，嵌入其中，确保扎实的承重，同时释放简洁通透的桌下空间。

The design draws inspiration from lotus leaves of varying sizes and shapes, using different textures and shades in the stack arrangement. The metal legs support the lotus leaf branches and ensure strong load-bearing, creating an airy and simple space beneath the table.

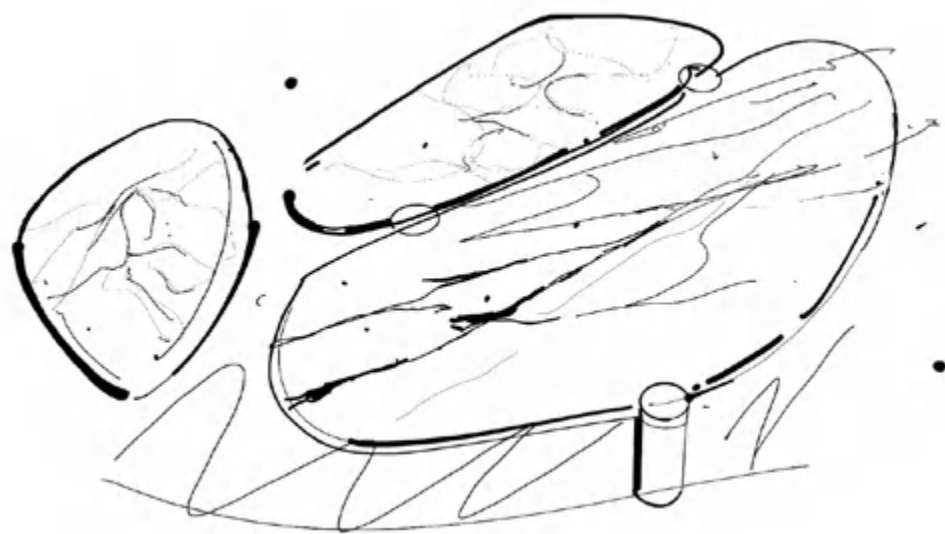

PLAY

戏剧派

编号: HT255 组合几

主材: 石材、不锈钢

尺寸: 1500*850*430H (mm) & 430*420*470H (mm)

Model: HT255 Coffee table

Main material: Marble, Stainless steel

Size: 1500*850*430H (mm) & 430*420*470H (mm)

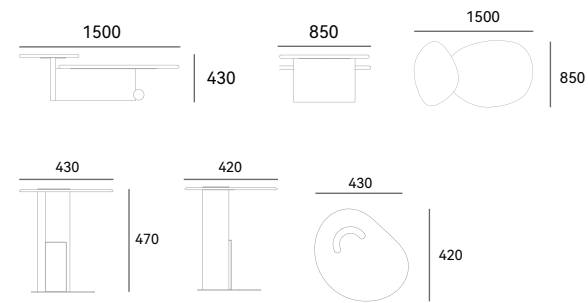

大小错落、材质各异的组合，构成了新的灵感画板，整个空间都被色彩所唤醒，灵感来自《菊次郎的夏天》中葱郁的荷叶与遥远的童年重叠，给了身体和灵魂得以喘息的间隙，大理石面板的冰冷，金属桌腿的坚硬全然被荷叶边似的弧度所接纳、软化、融入，成为家中和谐又独特的存在。

The combination of different sizes and materials forms a new inspiration drawing board, and the whole space is awakened by colors. Inspired by the lush lotus leaves in Kikujiro's Summer overlapping with distant childhood, it gives the body and soul a breathing space. The cold marble panel and the hard metal table legs are completely accepted, softened, and integrated by the ruff-like arc. Become a harmonious and unique presence in the family.



CURVE

曲线

编号: HT230 组合几

主材: 石材、不锈钢、玻璃

尺寸: 1500*850*360H (mm) & 1700*960*360H (mm)
& 700*420*440H (mm)

Model: HT230 Coffee table

Main material: Marble, Stainless steel, Glass

Size: 1500*850*360H (mm) & 1700*960*360H (mm)
& 700*420*440H (mm)

曲线, 是宇宙的真谛, 化为少数派的家族设计语言, 不拘一格的自我表达, 被赋予优雅和精致之感。探索色彩、材料和结构之间的微妙关系和张力, 金属与大理石的完美配比, 以曲线定义全新轻奢的生活方式。

Curve, is the true meaning of the universe, into the minority family design language, eclectic self-expression, is given a sense of elegance and refinement. Explore the subtle relationship and tension between color, material and structure, the perfect match of metal and marble, and define a new light luxury lifestyle with curves.

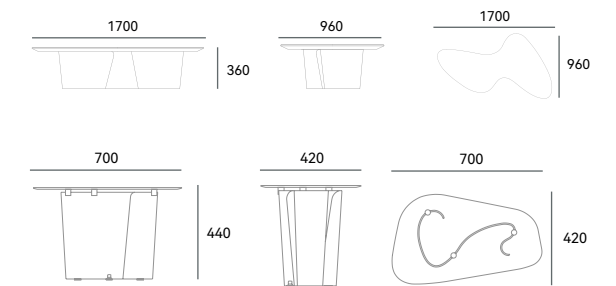

FUSION

融几

编号: HT256 组合几

主材: 石材、HDF 高密度板、染色白橡木皮、不锈钢

尺寸: 1410*810*395H (mm) & 540*440*480H (mm)

Model: HT256 Coffee table

Main material: Marble, HDF, Wood, Stainless steel

Size: 1410*810*395H (mm) & 540*440*480H (mm)



融几是由丰富材质、多种尺寸的模块“融合”在一起的长几系统，造型有着建筑般克制、对称、简约的特点，独具特色的金属镶嵌，呈现细节之美。多种材质的碰撞，既实现材料的跨界搭配，又体现自由拼接的生活方式，新奇而有趣。

The FUSION coffee table is a long table system composed of different-sized modules featuring rich materials and distinctive metal inlays, showcasing architectural simplicity and unique details. Through the integration of various materials, it embodies a novel and intriguing lifestyle of free splicing.

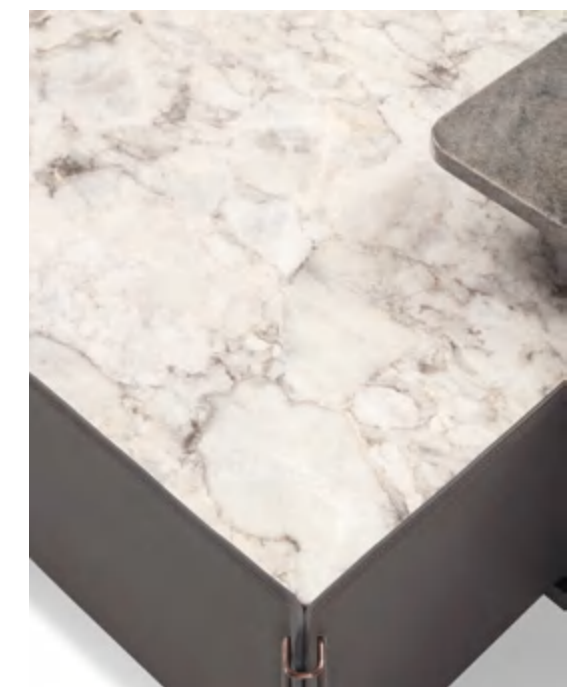
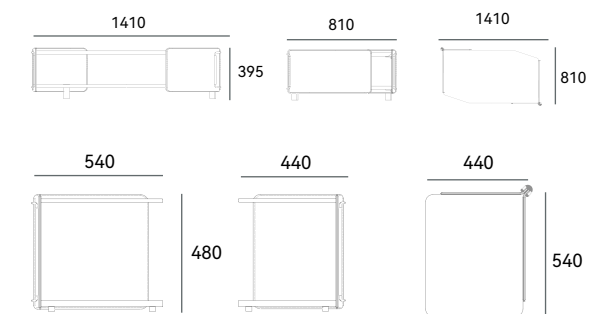



MUSHROOM

魔菇

编号: HT266 角几

主材: 不锈钢、玻璃钢、玻璃

尺寸: 600*350*520H (mm)

—

Model: HT266 Coffee table

Main material: Stainless steel, FRP, Glass

Size: 600*350*520H (mm)

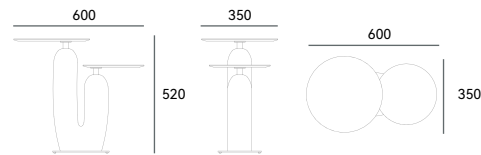

每个人的心里都有个魔法世界，藏着童年时代的信仰，藏着旖旎幻想的原动力，魔法世界并没有给我们魔法，却给了我们去创造的动力和相信自己的勇气，而这些，才是我们真实世界里最大的魔法，一棵向上生长的魔菇，希望为你的生活注入快乐的魔法。

Inside everyone's hearts resides a magical world, concealing the childhood beliefs and fantastical inspiration. This wondrous realm doesn't bestow magic, but rather ignites inner creativity and self-belief – the greatest magic in our everyday lives. Like a mushroom reaching upwards, it seeks to infuse your life with happiness and enchantment.



FOLDING

折叠艺术

编号: HT253 组合几

主材: 不锈钢、马鞍皮、石材

尺寸: 1020*1000*350H (mm) & 1350*620*350H (mm)

Model: HT253 Coffee table

Main material: Stainless steel, Marble, Leather

Size: 1020*1000*350H (mm) & 1350*620*350H (mm)

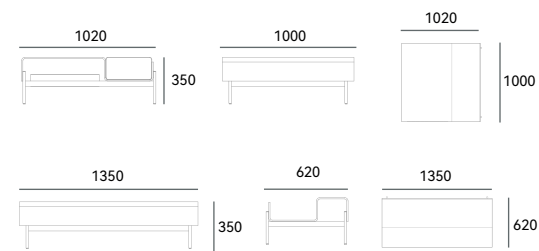

因独特的曲折而令人印象深刻, 是一款非常有态度的作品, 皮革、金属、大理石等多元素的加入, 打破思维局限, 个性低调却不失自我风格, 特立独行的设计理念, 可随意组合的造型艺术, 延续了无畏玩趣的品牌态度。

It impresses with its distinctive twists and turns, embodying a bold attitude through the incorporation of leather, metal, marble, and other elements that transcend conventional boundaries. Its understated yet stylish personality and unique design concept uphold the brand's fearless and playful attitude through random combinations.





WAVE

涟漪

编号: HT272 组合几

主材: 石材、不锈钢、玻璃钢

尺寸: 700*450*380 (mm) & 900*900*300 (mm)
& 1000*850*380 (mm)

Model: HT272 Coffee table

Main material: Marble, Stainless steel, FRP

Size: 700*450*380 (mm) & 900*900*300 (mm)
& 1000*850*380 (mm)

组合茶几由三个不同尺寸的茶几组成, 外观设计流畅自然, 线条柔和, 如同一朵朵浪花。桌面不规则的边缘点亮了空间的沉闷感, 圆润的曲线犹如流动的水面, 艺术与自然的新视觉碰撞, 塑造一种全新的审美体验, 宽大的桌面既是物品放置区, 也是艺术陈列区, 化繁为简营造空间的仪式感, 不多余的装饰是意境的艺术。

The combination coffee table consists of three coffee tables of different sizes. The appearance design is smooth and natural, with soft lines, like waves. The irregular edges of the tabletop light up the dull feeling of the space, and the round curves are like flowing water. The new visual collision of art and nature creates a new aesthetic experience.

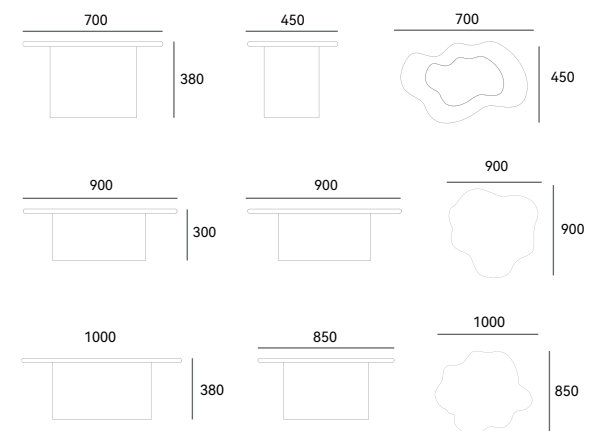

MOON

圆月

编号: HT227 组合几

主材: HDF 高密度板、岩板、不锈钢、石材

尺寸: $\Phi 1100 \times 340H$ (mm) & $\Phi 400 \times 400H$ (mm)

Model: HT227 Coffee table

Main material: HDF, Rock slabs, Stainless steel, Marble

Size: $\Phi 1100 \times 340H$ (mm) & $\Phi 400 \times 400H$ (mm)

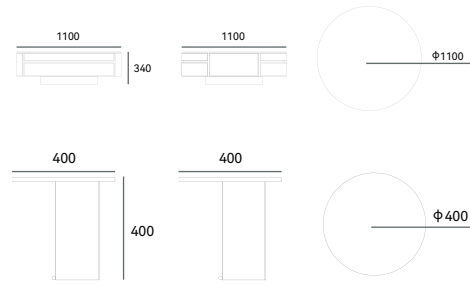

UFO

飞碟

编号: HT267 茶几

主材: 玻璃钢、灰玻

尺寸: $1250 \times 900 \times 295H$ (mm)

Model: HT267 Coffee table

Main material: FRP, Glass

Size: $1250 \times 900 \times 295H$ (mm)

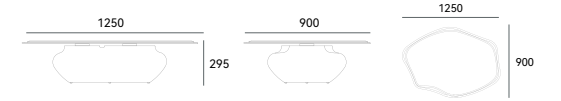

LINEA

线条

编号: HT268 边几

主材: 白蜡木、不锈钢、马鞍皮

尺寸: 650*390*550H (mm)

—

Model: HT268 Coffee table

Main material: Wood, Stainless Steel, Leather

Size: 650*390*550H (mm)

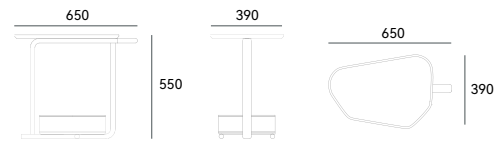

CIRCLE

圆融

编号: HT239 圆几

主材: 石材、白蜡木、不锈钢

尺寸: $\Phi 400$ *550H (mm)

—

Model: HT239 Coffee table

Main material: Marble, Wood, Stainless steel

Size: $\Phi 400$ *550H (mm)

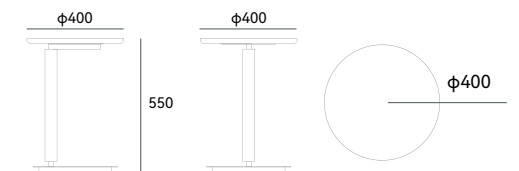

DINING TABLE

餐桌



INTERSTELLAR

星际系列

编号: HT276 长餐台

主材: 玻璃钢、HDF 高密度板、不锈钢

尺寸: 1800*900*760 (mm)

—

Model: HT276 Dining table

Main material: FRP, HDF, Stainless steel

Size: 1800*900*760 (mm)

以巨甲虫结构为灵感，创作了星际系列作品。将甲虫的力量感和特性融入家具造型，打造出流畅而富有动感的外形，融合自然美感和未来科技感，打造出既具有艺术价值又兼具实用性的产品，为用户带来全新的用餐体验。

The dining table draws inspiration from the giant beetle's structure, resulting in a dynamic and futuristic design. By integrating the beetle's power and characteristics, the table uniquely combines natural beauty and cutting-edge technology, offering users a novel dining experience with artistic and practical value.

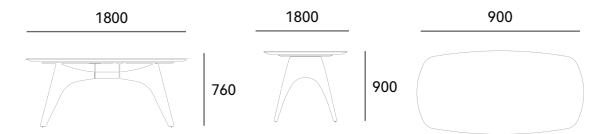

STARRY SKY

星空

编号: HT269 餐台

主材: 石材、HDF 高密度板、不锈钢

尺寸: $\Phi 1500 \times 750$ (mm)

—

Model: HT269 Dining table

Main material: Marble, HDF, Stainless steel

Size: $\Phi 1500 \times 750$ (mm)

黑，因极致而纯粹，凝结亿万年时光的美，宛如璀璨星空。选用纹理细腻丰富的银河星空奢石与金属底座结合，极具建筑感的结构、利落流畅的线条，平衡稳重但轻盈的视觉感受，简约而不简单，不同材质在空间中碰撞，每一处细节都潜藏匠心，精致且复古的质感，适用于不同风格的餐厅搭配。

Black, pure because of the extreme, condenses the beauty of billions of years of time, like a bright star. The combination of Milky Way star luxury Marble with rich and delicate texture and metal base, has a very architectural structure, crisp and smooth lines, balanced and stable but light visual experience, simple but not simple, different materials collide in the space, every detail has hidden originality, exquisite and retro texture, suitable for different styles of restaurant collocation.

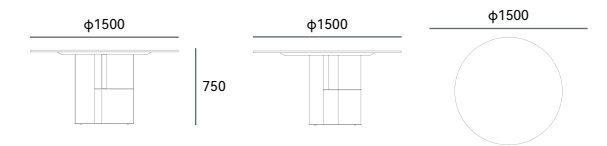

UNLIMITED

无限系列

编号: HT266 长餐台

主材: 石材、HDF 高密度板、玻璃钢

尺寸: 2200*1100*760 (mm)

Model: HT266 Dining table

Main material: Marble, HDF, FRP

Size: 2200*1100*760 (mm)

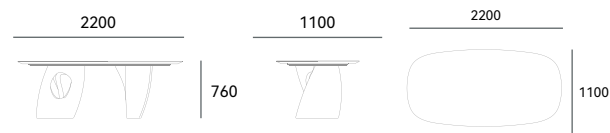

灵感来自电影《阿凡达》中充满神秘能量的智慧树圣母 Eywa，以智慧树的象征意义打造独特的建筑形态，将象征着生命与自然的纯洁力量带入到设计中，表达生命力量的传递与延续和自然界中的平衡与和谐，采用了仿生学原理，桌腿形似古树，三根遒劲树枝自树干延伸而出，造型极具未来先锋感，为餐桌注入生机与活力。

Inspired by Eywa, a wisdom tree full of mysterious energy in the movie Avatar, she creates a unique architectural form with the symbolic meaning of wisdom tree, bringing the pure power symbolizing life and nature into the design, expressing the transmission and continuation of life force and the balance and harmony in nature. The bionic principle is adopted, and the table legs are shaped like ancient trees. The three sturdy branches extend from the trunk, and the shape is very futuristic and pioneering, injecting vitality and vitality into the table.



UNLIMITED

无限系列

编号: HT266 餐台

主材: 石材、HDF 高密度板、玻璃钢

尺寸: 1500*1000*750/Φ1350*750(mm)

Model: HT266 Dining table

Main material: Marble, HDF, FRP

Size: 1500*1000*750/Φ1350*750(mm)

桌腿采用了仿生学原理，独特的现代雕塑感为空间注入了时尚和精致的元素；在曲线中融入中国建筑“漏景”的艺术设计手法，每个角度都可以看到不同的风景，同时减少设计的闭塞感，增加产品的趣味感和形式感。

The table leg is inspired by bionics, incorporating modern sculpture to bring a fashionable and exquisite vibe to the space. Its artistic Chinese architectural design allows different scenery to be seen from every angle, reducing the sense of closure and increasing the product's fun and form.

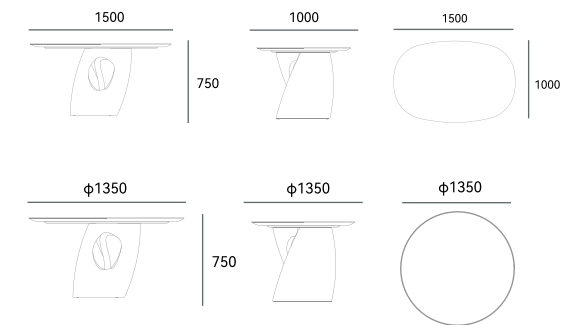





METROPOLIS

大都会

编号: HT257 长餐台

主材: 石材、玻璃钢

尺寸: 2200*1100*750H (mm)

Model: HT257 Dining table

Main material: Marble, FRP

Size: 2200*1100*750H (mm)

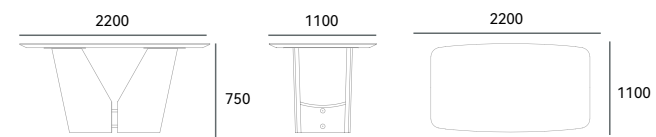

餐台灵感来自充满活力和创新的大都会，它捕捉了城市的能量和快节奏的生活方式，并将其转化为独特的形态和结构。材质碰撞代表了现代工业和建筑的特征，曲面设计则呈现出一种动感和流畅感，以其独特的现代雕塑感，为空间注入了时尚和精致的元素。

Taking cues from dynamic and cutting-edge urban centers, this dining table embodies the fast-paced energy of the city in its distinct forms and structures. The fusion of materials mirrors modern industry and architecture, while the curved design infuses the space with a sleek and fashionable touch, evoking a modern sculpture sensibility.

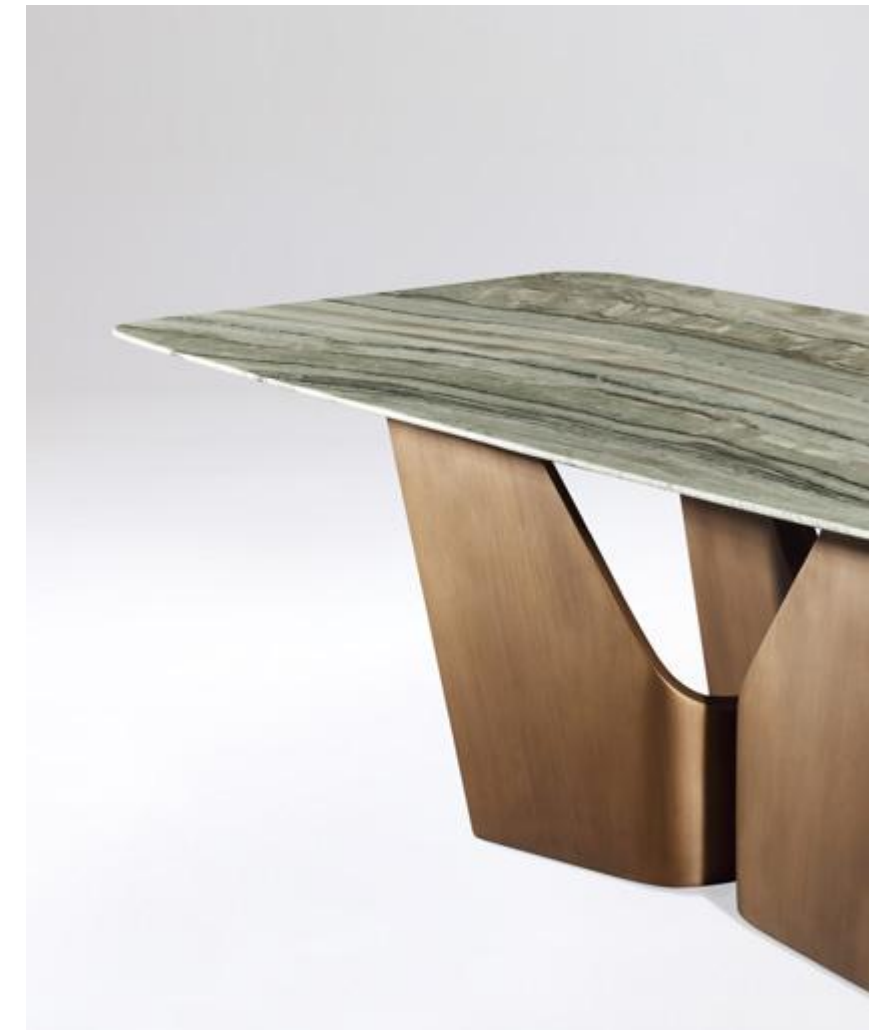



CHAIN 链

编号: HT228 圆餐台

主材: 石材、不锈钢、玻璃钢

尺寸: $\Phi 1350 \times 760H$ (mm)

—

Model: HT228 Dining table

Main material: Marble, Stainless steel, FRP

Size: $\Phi 1350 \times 760H$ (mm)



当 Chain 餐桌摆放在空间时, 其稳固而别致的结构更像一个雕塑。桌腿采用链条一般的交错衔接, 边缘用细腻的曲线, 磨出大理石的极致厚度, 圆滑的收口深精妙工艺和顶级材质的双重体现, 底座通过几个同样的体块, 精确的重新排列和组合, 如链条般紧紧相连, 从不同角度看去, 整个桌腿虚实相间, 既是实用家居物品, 也不失突破常规的趣味性和品格。

The table legs are intricately woven like chains and feature elegant curved edges to maximize the marble thickness. The precise arrangement of identical blocks creates a tight, interconnected base with alternating virtual and real perspectives. This piece is not just practical, but also carries a playful and rebellious character, showcasing outstanding craftsmanship and high-quality materials.

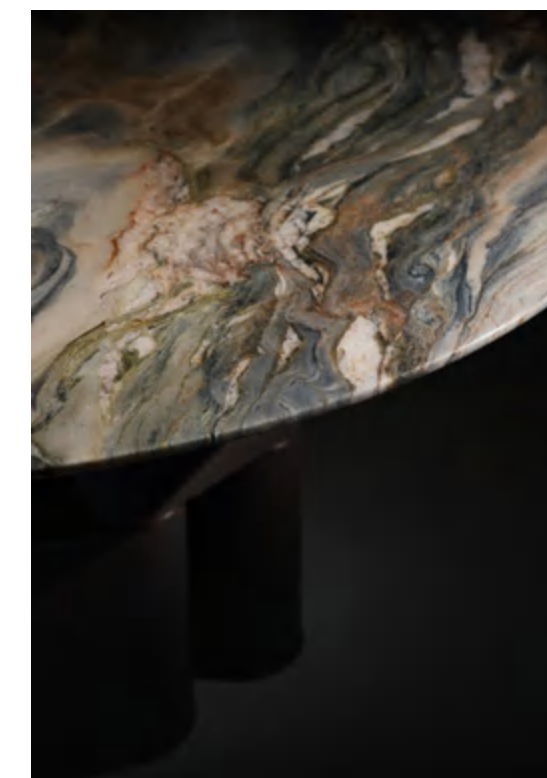
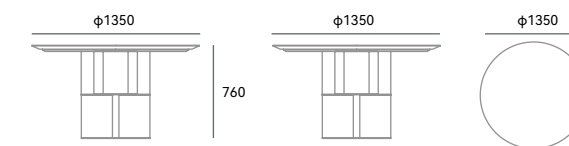

餐台可根据客户需求定制不同直径的尺寸，适用于家庭、餐厅、酒店等不同场合；大理石的台面经过精细加工和抛光处理，表面光滑且易于清洁；餐桌腿采用多面不规则设计，其独特的形状和颜色展现出山脉的雄伟与力量。

The dining table can be tailor-made in various diameters to suit the needs of customers for different occasions, such as for families, restaurants, and hotels. The marble countertops are meticulously crafted and polished, providing a smooth and easy-to-clean surface. The table legs have distinct and irregular shapes and colors, symbolizing the grandeur and strength of mountains.



SEASON

四季

编号: HT268 中岛台

主材: 石材、HDF 高密度板

尺寸: 3200*950*850H (mm)

Model: HT268 Central island

Main material: Marble, HDF

Size: 3200*950*850H (mm)

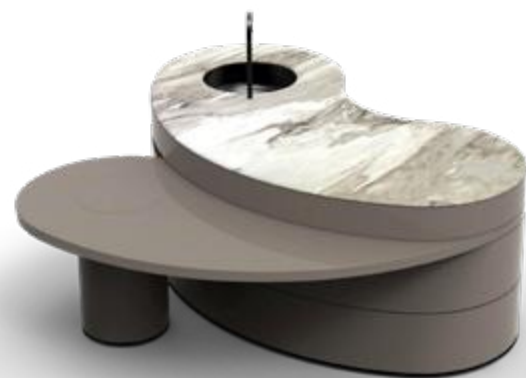
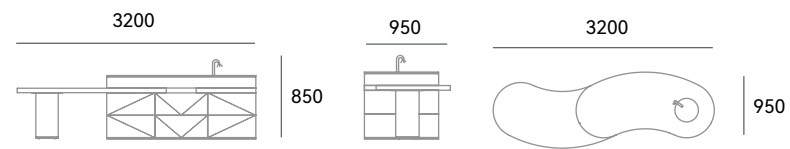

优雅的曲线构成家中流畅的动线，连接的餐桌还可折叠收起，整体收纳、更省空间，一屋两人三餐四季，见证细水长流的自在安稳。

The elegant curves contribute to the home's structure, and the interconnected dining table can be folded and stored, saving space. This setup supports the freedom and stability one needs.

超大的操作台面、清晰的圆润线条，让整个餐厅清爽简洁，充足的储物空间和合理的功能区分配，让人自如享受厨房与爱，极简的风格不会喧宾夺主。

The restaurant features an expansive work surface and sleek, rounded lines, creating a refreshing and uncluttered atmosphere. Ample storage and well-designed functional areas allow for easy kitchen enjoyment and a minimalist style that doesn't overwhelm.

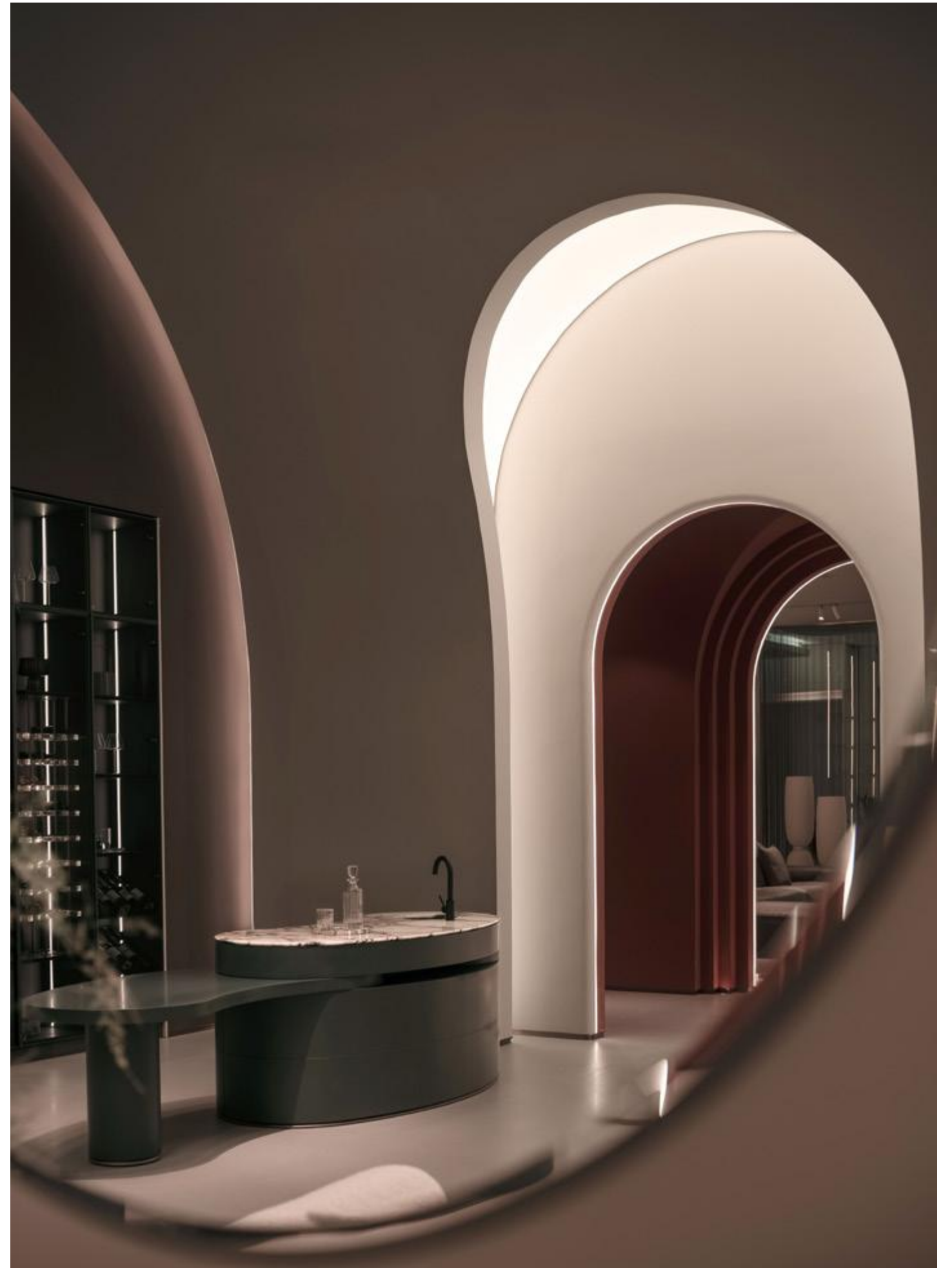



CURVE

曲面

编号: HT256 长餐台

主材: 石材、不锈钢

尺寸: 1800*900*750H (mm)

—

Model: HT256 Dining table

Main material: Marble, Stainless steel

Size: 1800*900*750H (mm)

将瓦片的灵感设计融入桌腿的设计中，提升雕塑感的同时，巧妙组合，桌面圆角过渡更加人性化，圆润一体，搭出时光荏苒中的美好。哑光的金属质感为其增添沉稳气势，通过夸张的曲面变化形成极具张力的视觉效果，整体造型极具未来感。

Incorporating the tile-inspired design into the table legs enhances the sculptural sense and seamlessly complements the rounded corner transition of the tabletop, creating a timeless and beautiful aesthetic. The matte metal texture adds tranquility, exaggerated surface changes deliver a striking visual impact, and the overall shape exudes a futuristic vibe.

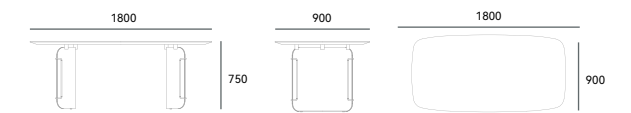

MUSHROOM

蘑菇

编号: HT237 长餐台

主材: HDF 高密度板、染色白橡木皮、玻璃钢、石材

尺寸: $\Phi 1500 \times 750$ (mm)

—

Model: HT237 Dining table

Main material: HDF, Wood, FRP, Marble

Size: $\Phi 1500 \times 750$ (mm)

圆餐台的造型灵感来自蘑菇的精致曲线, 以一种意想不到的优美方式颠覆设计, 桌腿伞状式的结构简洁明了, 平添了几分沉稳安静的氛围。中间的小圆形奢石桌面可自由转动, 满足众人就餐的需要。

The round dining table's shape draws inspiration from the delicate curves of mushrooms, offering an unexpected and beautiful design. The umbrella-like structure of the table legs creates a calm and serene atmosphere, while the luxury marble tabletop in the middle can rotate freely to accommodate all diners.

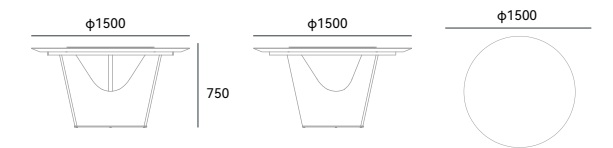

NORA

诺拉

编号: HT229 餐台

主材: 石材、玻璃钢、不锈钢

尺寸: 2400*1100*750H (mm)

—

Model: HT229 Dining table

Main material: Marble, FRP, Stainless steel

Size: 2400*1100*750H (mm)

当夜幕降临，星辰闪烁，以其独特的雅丹黑台面，引领我们走进一个充满神秘与优雅的用餐空间，宛如夜空般深邃。每一寸表面都散发着低调而奢华的光泽，仿佛是艺术家笔下的杰作，让每一次用餐都成为一场视觉盛宴。无论家庭聚会或是独自享用的晚餐，都变得格外珍贵。

As night arrives, the twinkling stars guide us to a dining space with a mysterious and elegant Yadan black countertop, reminiscent of the deep night sky. Every inch exudes a subtle yet luxurious luster, akin to an artist's masterpiece, transforming every meal into a visual feast, whether shared with family or enjoyed alone, creating precious moments.

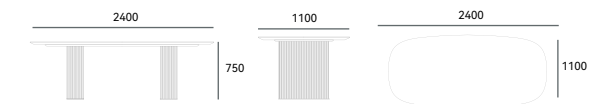

TWIST

扭曲的时间

编号: HT230 餐台

主材: 石材、不锈钢

尺寸: 2200*1100*750H (mm)

—

Model: HT230 Dining table

Main material: Marble, Stainless steel

Size: 2200*1100*750H (mm)

少数派来自未来，灵感来源于独立馆外观，天然去雕饰的畅然质感，造型柔和圆润，线条流畅婉转，仿佛水和空气塑造而成，在独特的曲线圆柱形桌腿衬托下，呈现出一种不断变化的流动之感，赋予空间节奏与仪式的美感。

The minority comes from the future, inspired by the appearance of the independent museum, which is naturally decorated with smooth texture, soft and round shape, smooth and graceful lines, as if shaped by water and air. Under the unique curved cylindrical table legs, it presents a sense of ever-changing flow, giving the space rhythm and ritual beauty.



SQUARE&CIRCLE

方圆

编号: HT268 圆餐台

主材: 石材、HDF 高密度板、不锈钢

尺寸: $\Phi 1800 \times 750$ (mm)

—

Model: HT268 Dining table

Main material: Marble, HDF, Stainless steel

Size: $\Phi 1800 \times 750$ (mm)

设计师受到毕加索对于几何形状的运用和启发，创造了这款餐桌。当线与面在脑海中，被赋予无穷的想象与组合，重复的生活也有了不重复的模样，方形桌腿与圆形桌面的拼合，让整个餐桌有着搭积木般的趣味，镂空的弧形，使得人与人、人与空间更有交流感，餐桌配有可升降圆盘，为家庭使用增加了便捷性。

The designer was inspired by Picasso's use of geometric shapes to create this dining table. The dining table is equipped with a liftable disc, for the family use to increase the convenience.

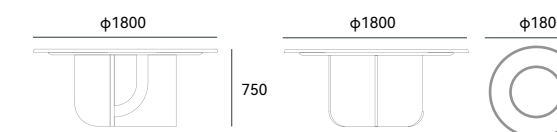



现代化的升降旋转设计，不仅实用性强，外观也更加时尚美观，能为就餐环境增添不少格调。升降功能可以根据需要调整餐台的高度，在不同场合使用，让就餐者更加舒适；还可以根据客户需求定制不同直径的尺寸，适用于家庭、餐厅、酒店等不同场合。

The contemporary lifting and rotating design is not just practical but also adds a stylish and elegant touch to any dining space. The adjustable function caters to various occasions, ensuring diners are comfortable. Customizable diameters make it suitable for use in homes, restaurants, and hotels.

LEILA

莉拉

编号: HT211S 圆餐台

主材: 石材、HDF 高密度板、玻璃钢

尺寸: $\Phi 1500 \times 755H$ (mm)

—

Model: HT211S Dining table

Main material: Marble, HDF, FRP

Size: $\Phi 1500 \times 755H$ (mm)

在家的中心，莉拉圆形餐桌以其独特的魅力，旋转出一段时光的圆舞曲，邀请每一位宾客步入这场复古与现代交织的梦幻宴会。台面的大理石宛如夜空中最亮的星辰，汇聚成一片璀璨的银河。圆形的轮廓，象征着团圆与和谐，每一次围坐，都是心灵相通的开始。

The LEILA round dining table blends vintage and modern charm with its unique jade and bright marble countertop, symbolizing unity and harmony beneath a brilliant galaxy-like design. Sitting around it always marks the start of heartfelt connections.

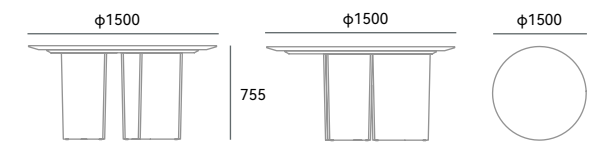

ARMCHAIR

扶手椅

FREE

天使之翼

编号: HT263 无扶手椅
主材: 玻璃钢、内架实木
尺寸: 670*560*780H (mm)
—
Model: HT263 Chair
Main material: FRP, Wood
Size: 670*560*780H (mm)



这款扶手椅的靠背呈现出翅膀的形状，两侧展开，仿佛天使展翅飞翔的姿态，充满着令人心驰神往的幻想与想象，是自由与不被定义的代表，旨在营造一种轻盈、优雅和神秘的氛围，为追求独特、优雅和艺术品味的少数派提供一种全新的休闲体验。

The Free armchair features wing-shaped backrests that symbolize freedom and imagination, creating an atmosphere of elegance and mystery for those seeking exclusivity and artistic sophistication.

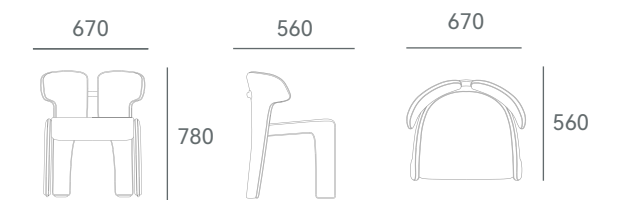



WINDBREAKER

风衣

编号: HT269 扶手椅

主材: 不锈钢、玻璃钢

尺寸: 720*630*770H (mm)

—

Model: HT269 Armchairs

Main material: Stainless steel, FRP

Size: 720*630*770H (mm)

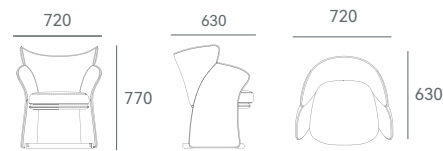

来自经典风衣的设计灵感，一体成型的圆弧靠背进一步加强了它的柔美气质，赋予风衣扶手椅独特的优雅，带给我们精致的现代感，向后微倾的角度使身体彻底放松下来，感受生活。同时扶手张开的弧度，如同一个亲人的拥抱，永远以最热烈的姿态，欢迎你回家。

Inspired by the classic trench coat, the one-piece rounded backrest further strengthens its feminine temperament, giving us a sophisticated modern feel, and the slight tilt angle allows the body to completely relax and feel life. At the same time, the open arc of the armrest, like a hug of a loved one, will always welcome you home with the warmest attitude.



SWAN

天鹅椅

编号: HT269 无扶手椅

主材: A3 钢、玻璃钢

尺寸: 530*600*780H (mm)

—

Model: HT269 Chair

Main material: Level of steel, FRP

Size: 530*600*780H (mm)

其设计灵感来源于天鹅的形态。经过精心的设计与考量，柔和的曲线从椅背延伸到底座，诠释出优雅的生活态度。舒适感极佳的靠背与座位构成灵动的外观，极具辨识度，舒适度不减却不用占用大量空间。流畅的线条之下是深埋细节的精致工艺，如时尚的符号，可百搭任意空间。

Taking inspiration from a swan's form, this design features a soft curve extending from the chair's back to its base, embodying an elegant attitude towards life. The comfortable backrest and seat create a distinctive and space-saving dynamic appearance. Amidst the smooth lines lies detailed craftsmanship, making it a fashionable and versatile addition to any space.

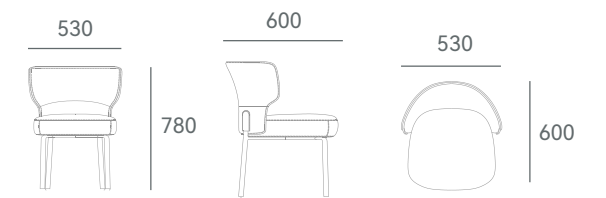

YUPPIES

雅皮士

编号: HT227 扶手椅

主材: 内架多层实木板、不锈钢

尺寸: 620*600*860H (mm)

—

Model: HT227 Chair

Main material: Solid wood, Stainless steel

Size: 620*600*860H (mm)



设计灵感来自于 1980 年代美国的雅皮士文化, 设计师希望通过这款椅子, 展现出雅皮士文化的精致、时尚和现代感。镜面深褐金的椅腿底部以及座位底部作为整体框架结构, 象征着奢华和稳固。靠背中间的精致走线设计, 则代表着雅皮士文化的细腻和考究。整体墨绿色的设计, 则给人一种沉稳、低调而高贵的感觉。

The design of the chair draws inspiration from the 1980s yuppie culture in the United States, aiming to reflect sophistication, fashion, and modernity. The mirrored dark brown gold chair leg bottoms and seat bottom symbolize luxury and stability, while the intricate wiring design in the backrest represents the delicacy and sophistication of yuppie culture. The dark green overall design exudes a calm, low-key, and noble feeling.

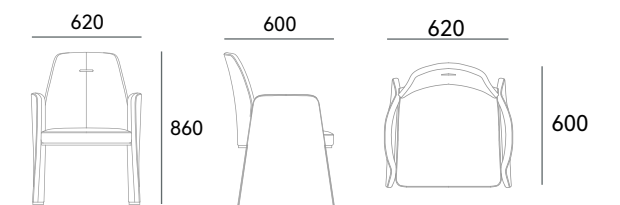

SEMIQUAVER

音符

编号: HT228K 扶手椅

主材: 内架实木、内架多层实木板、A3 钢、不锈钢

尺寸: 710*600*790H (mm)

—

Model: HT228K Chair

Main material: Solid wood, Level of steel, Stainless steel

Size: 710*600*790H (mm)

音符餐椅灵感源于设计师 Doris 维也纳之旅，由功能出发，突破传统的造型结构，靠背与前腿、座垫与扶手，似连非连，轻盈又稳固，像跳动在空间中的音符，旋律就在不自觉中缓缓流淌。设计灵感来自于音乐的节奏和旋律，以及音乐符号的独特形状。

Note dining chair inspired by the designer Doris Vienna trip, from the functionality, break through the traditional modeling structure, backrest and front legs, seat cushion and armrests, seems to be connected and not connected, light and solid, like a note jumping in the space, the melody is in the unconscious slow flow. The design is inspired by the rhythm and melody of music, as well as the unique shape of music symbols.

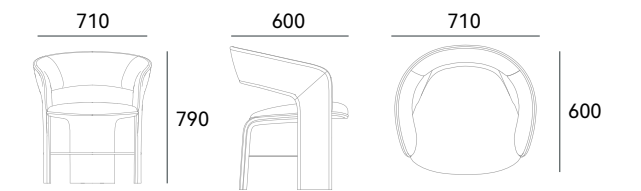

FILM

菲林

编号: HT252 无扶手椅

主材: 内架多层实木板、A3 钢

尺寸: 580*560*840H (mm)

Model: HT252 Chair

Main material: Solid wood, Level of steel

Size: 580*560*840H (mm)

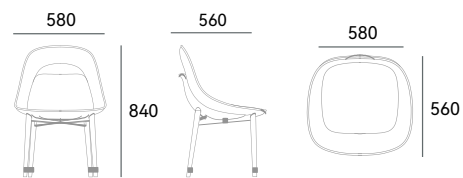

菲林餐椅如同具有独特风格的缪斯女神，第一眼就足以吸引所有人的目光。双色的拼接和组合，像一张卷起的菲林胶片，让人有随时随地坐下轻松休息的魅力。既是实用的家居物品，也不失突破常规的趣味性和格调。

The Film dining chair stands out with its unique style, two-color design, and charm. It doubles as a practical household item and a trendy unconventional statement.



EMBRACE

抱抱椅

编号: HT257 无扶手椅

主材: 内架多层实木板、A3 钢

尺寸: 630*590*830H (mm)

Model: HT257 Chair

Main material: Solid wood, Level of steel

Size: 630*590*830H (mm)

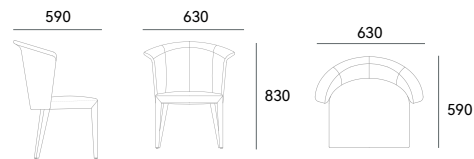

抱抱椅的设计灵感来自给你一个“大大的拥抱”，整体形态干练而优雅，兼具美感与辨识度。3D 曲面造型椅背，与扶手连贯形成起伏曲线，环抱式承托背部，依靠的同时，肩部和背部的支撑十分踏实，舒适自如。设计师希望通过这款椅子，营造出一种亲密、舒适和温馨的坐感，让人们在家中感受到家的温暖和安全感。

The design of the hug chair is inspired by giving you a "big hug". The overall shape is capable and elegant, with both beauty and recognition. The designer hopes to use this chair to create an intimate, comfortable and warm sitting feeling, so that people can feel the warmth and security of home at home.

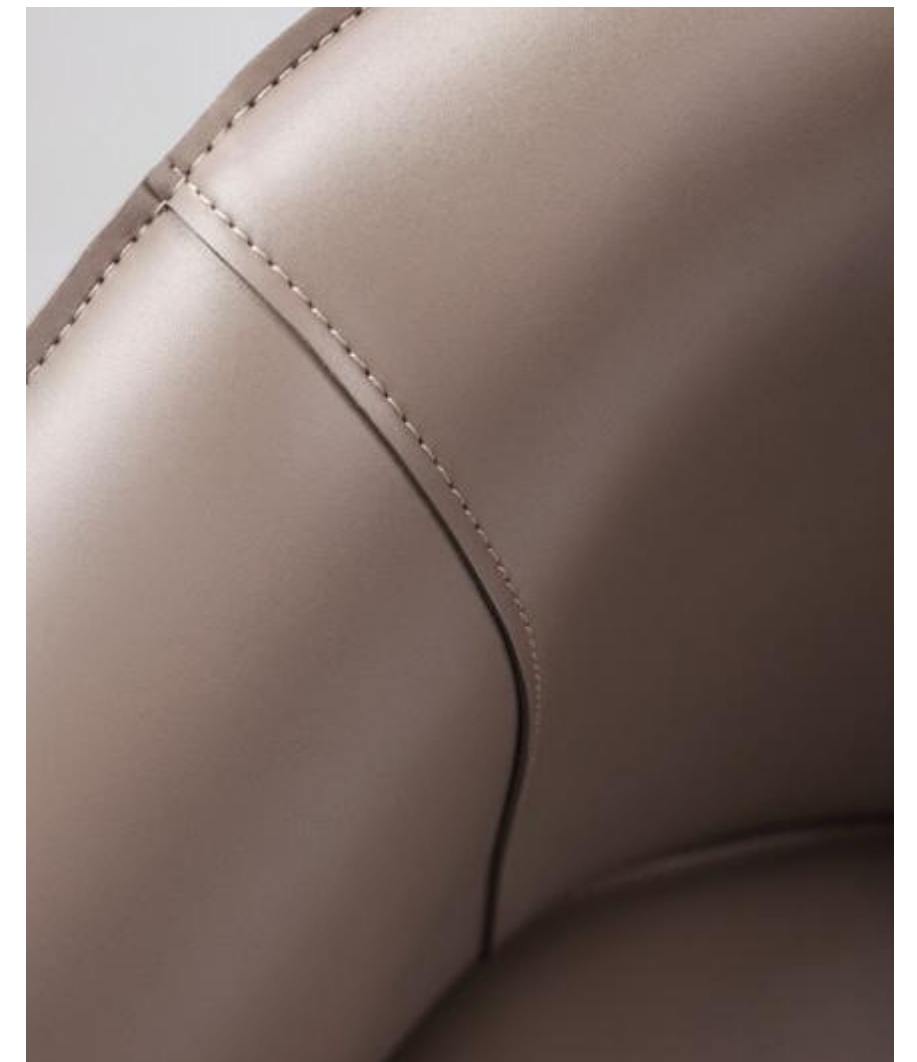

SCALA

斯卡拉

编号: HT238 扶手椅

主材: 内架多层实木板、A3 钢、不锈钢

尺寸: 670*580*800H (mm)

Model: HT238 Chair

Main material: Solid wood, Level of steel, Stainless steel

Size: 670*580*800H (mm)

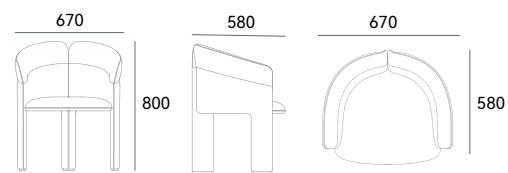

设计师从斯卡拉歌剧院内部, 具有对称结构的马蹄形池座, 提炼灵感转化变形, 赋予餐椅微妙的对称和舒适的坐感, 用餐也变成了一桩有仪式感的事情。椅背圆滑流畅的线条勾勒出优雅与情调, 柔和浪漫的外观, 最终呈现出另一种独特的复古风格。

The designer drew inspiration from the symmetrical structure of the horseshoe-shaped pool seat at La Scala Opera House to create dining chairs with subtle symmetry and a comfortable seating experience. Dining has evolved into a ritual, with the chair's sleek lines and soft, romantic appearance presenting a unique retro style.

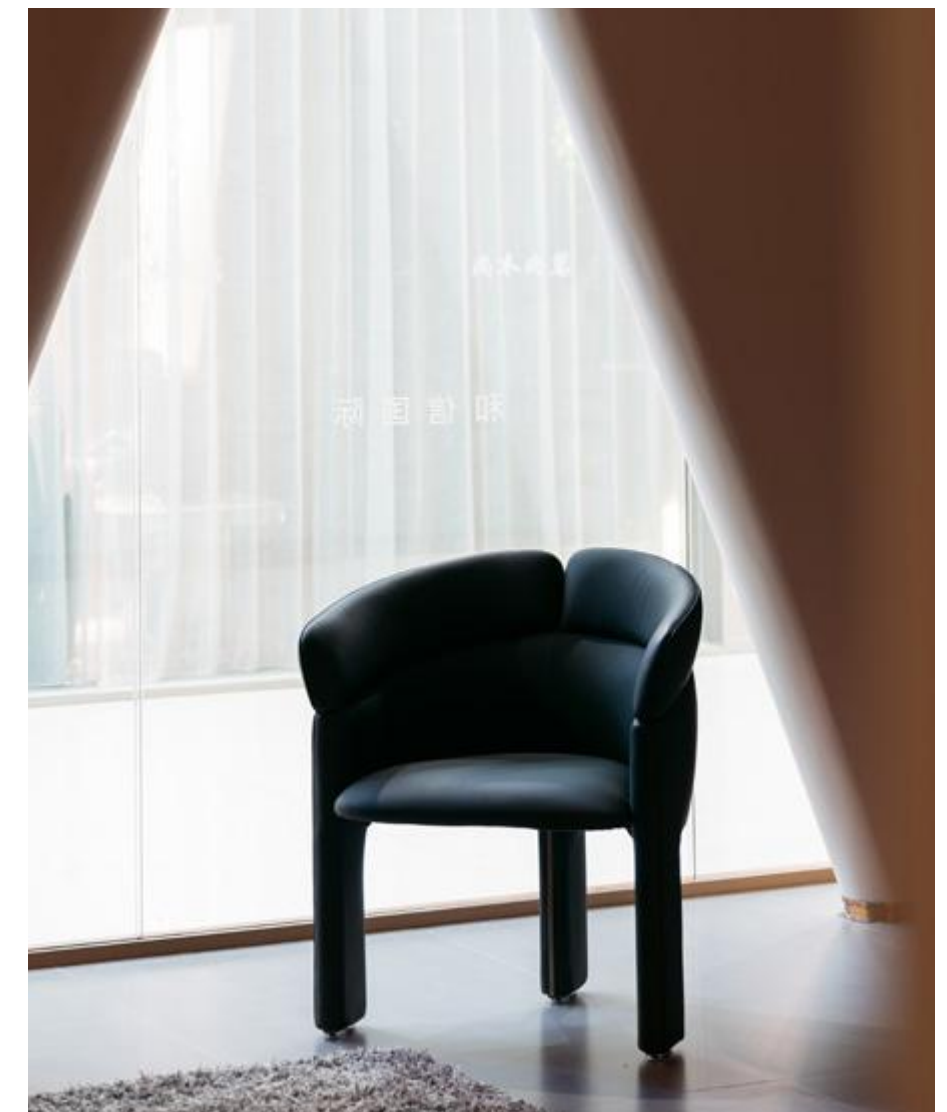

CABINETS

边柜



STREAM

流水

编号: HT230 餐边柜

主材: 石材、HDF 高密度板、不锈钢

尺寸: 1800*480*800H (mm)

—

Model: HT230 Cabinets

Main material: Marble, HDF, Stainless steel

Size: 1800*480*800H (mm)

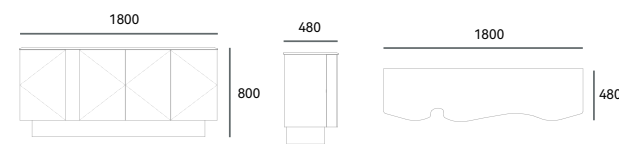

HILL

山丘

编号: HT238 酒柜

主材: 石材、HDF 高密度板、花曲柳木皮、不锈钢

尺寸: 1050*450*1600H (mm)

Model: HT238 Cabinets

Main material: Marble, HDF, Solid wood, Stainless steel

Size: 1050*450*1600H (mm)

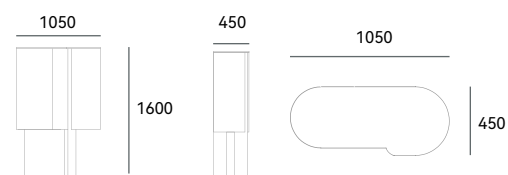

HERMIT

隐士

编号: HT268 边柜

主材: 玻璃、石材、HDF 高密度板、不锈钢

尺寸: 1800*500*800H (mm)

—

Model: HT268 Cabinet

Main material: Glass, Marble, HDF, Stainless steel

Size: 1800*500*800H (mm)

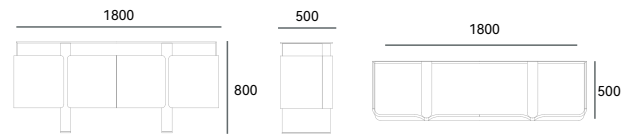

TIME

时光

编号: HT227 餐边柜

主材: 石材、HDF 高密度板、染色白橡木皮、不锈钢、玻璃

尺寸: 2000*490*810H (mm)

Model: HT227 Cabinet

Main material: Marble, HDF, Solid wood, Stainless steel, Glass

Size: 2000*490*810H (mm)

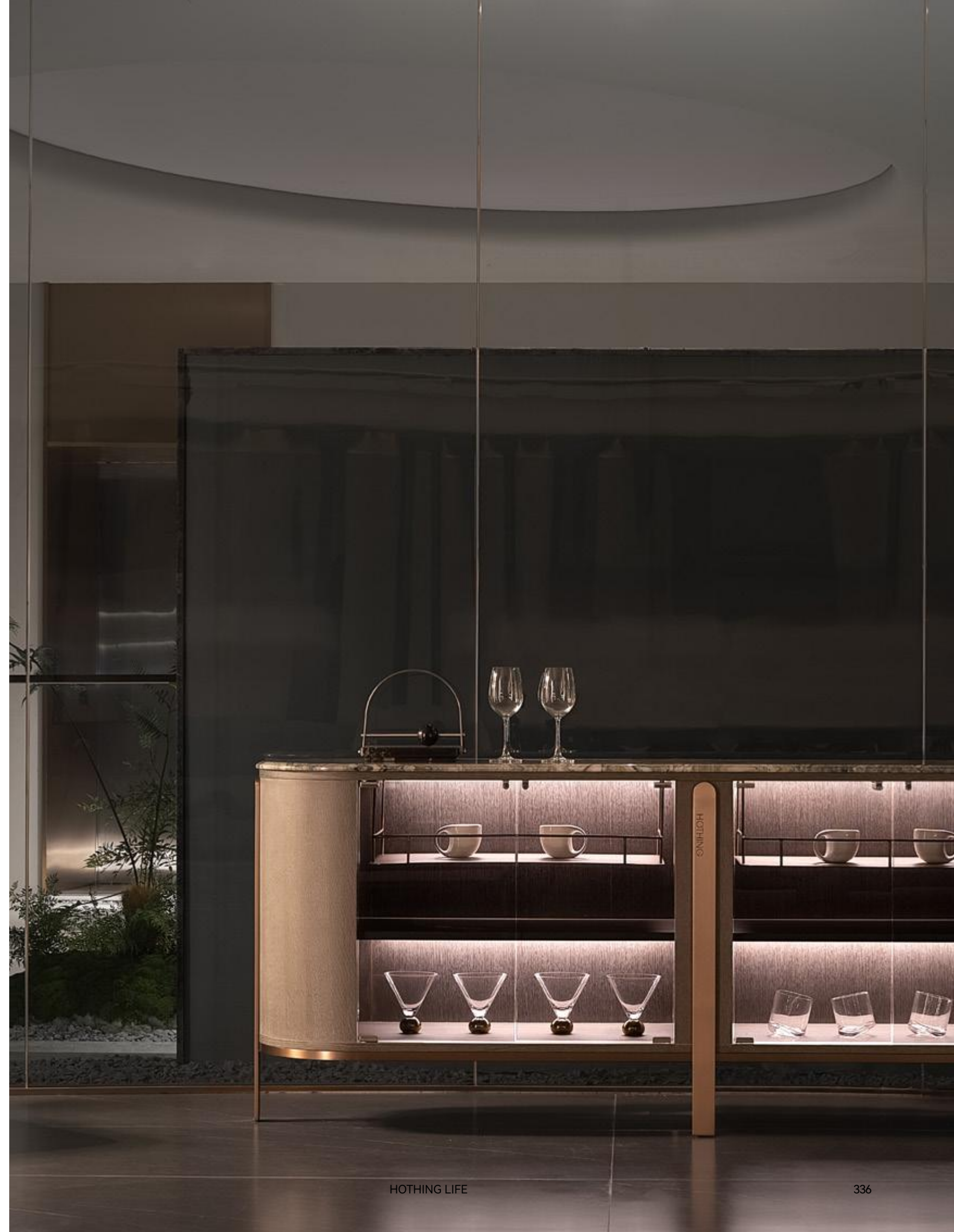
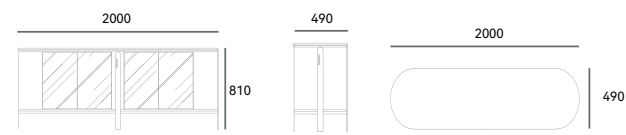

CrystalGrey

晶灰

编号: HT218 餐边柜

主材: HDF 高密度板、染色白橡木皮、岩板、不锈钢

尺寸: 1800*560*900H (mm)

Model: HT218 Cabinet

Main material: HDF, Solid wood, Rock slabs, Stainless steel

Size: 1800*560*900H (mm)

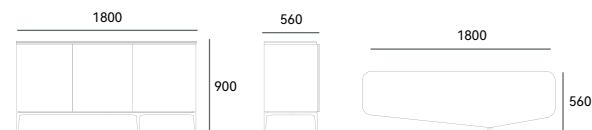

CrystalGrey

晶灰

编号: HT218A 地柜

主材: HDF 高密度板、染色白橡木皮、玻璃、不锈钢、岩板

尺寸: 1805*525*490H (mm)

Model: HT218A Cabinet

Main material: HDF, Solid wood, Glass, Stainless steel, Rock slabs

Size: 1805*525*490H (mm)

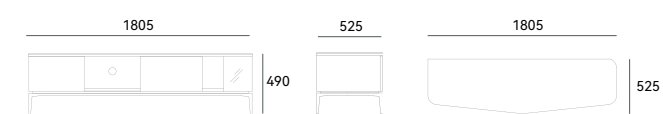

Night Systems

卧室空间





编号: HT227 床
 主材: 内架实木、内架多层实木板、不锈钢
 尺寸: 开: 3460*2400*1050H (mm)
 合: 2800*2400*1050H (mm)

Model: HT227 Bed
 Main material: Solid wood, Stainless steel
 Size: Expand: 3460*2400*1050H (mm)
 Collapse: 2800*2400*1050H (mm)

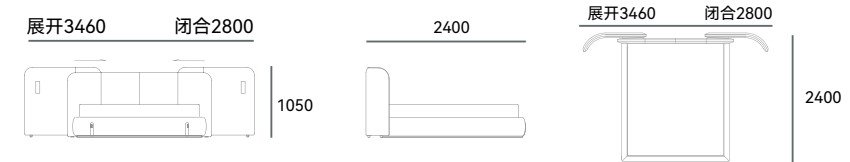



DUMBO 小飞象

可移动的床屏像极了小飞象飞翔时的样子，它扑扇着两只大大的耳朵，以一种极为柔软的姿态，就像在迎接你。HOTHING 通过有善意的设计，传递最自在快乐的生活状态与态与夸张俏皮幽默的碰撞，既时尚也更平易近人。

The movable bed screen resembles Dumbo flying with its large ears, welcoming you with a soft gesture. Through thoughtful design, HOTHING combines comfort and joy with playful humor, creating a fashionable yet approachable aesthetic.



编号: HT227A 床

主材: 内架实木、内架多层实木板、不锈钢

尺寸: 2170*2220*1000H (mm)

Model: HT227A Bed

Main material: Solid wood, Stainless steel

Size: 2170*2220*1000H (mm)



编号: HT277 床

主材: 内架多层实木板、不锈钢

尺寸: 2420*2240*1150H (mm)

Model: HT227 Bed

Main material: Solid wood, Stainless steel

Size: 2420*2240*1150H (mm)



LIGHT 浮光

浮光床的核心理念是融合简约与舒适，干净的线条和实用的设计营造出一种宁静感，就像一块宁静的休息画布。整体设计极简优雅，精巧柔和，是一款增强卧室的颜值和舒适度的独特产品。

The Floating Light Bed combines simplicity and comfort with clean lines and practical design to create a serene and elegant bedroom centerpiece.

床头内置的触摸式阅读灯，采用了极简的金属管形式，确保了功能性的同时不妨碍美感；提供上下两个方向的照明，创造出适合阅读或放松的舒适多变的氛围。

The touch reading lamp built into the bedside adopts a minimalist metal tube form to ensure functionality without hindering the aesthetics; it provides lighting in both upper and lower directions, creating a comfortable and varied atmosphere suitable for reading or relaxing.

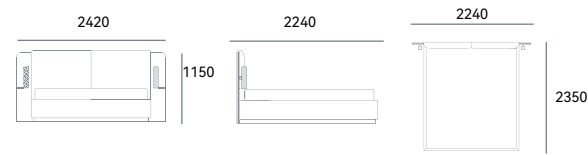



EMBRACE

怀抱

编号: HT273 床

主材: 内架多层实木板、A3 钢

尺寸: 2330*2350*1150H (mm)

—

Model: HT273 Bed

Main material: Solid wood, Level of steel

Size: 2330*2350*1150H (mm)

床屏张开的弧度犹如一个大大的拥抱，仿佛家人张开的温暖手臂，依靠的同时，肩部和背部的支持十分踏实，给予人安全的力量和依靠，充满温情，让睡眠舒适自如。

The curvature of the bed screen is like a big hug, like the warm arms of the family, relying on it at the same time, the support of the shoulders and back is very solid, giving people the strength and reliance of safety, full of warmth, so that sleep is comfortable and free.

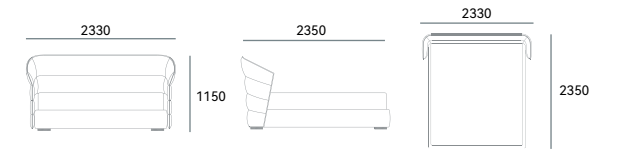

采用曲线设计，打造柔和的围合感；围合式设计能够营造温馨、舒适的睡眠环境，提升整个卧室空间的美感和品质感。

The curved design creates a soft sense of enclosure; the enclosed design can create a warm and comfortable sleeping environment and enhance the beauty and quality of the entire bedroom space.





CLOUD

云端

编号: HT276 床

主材: 内架多层实木板、不锈钢

尺寸: 1860*2350*990H (mm)

Model: HT276 BED

Main material: Solid wood, Stainless steel

Size: 1860*2350*990H (mm)



CLOUD 床是一款注重舒适度和质感的设计，躺在饱满的靠包上，让人仿佛置身于云端般轻盈的感觉中，踏上一段奇妙的旅程，让思绪得到释放，生活得到滋养，提供最佳的睡眠体验。

The CLOUD bed is designed with comfort and texture in mind, lying on a full backrest bag, making people feel as if they are in the lightness of the clouds, embarking on a wonderful journey, allowing the thought to be released, life to be nourished, and to provide the best sleep experience.





TWILIGHT

暮光

编号: HT268 床

主材: 内架实木、内架实木多层板、A3 钢

尺寸: 2130*2370*1110H (mm)

—

Model: HT268 Bed

Main material: Solid wood, Level of steel

Size: 2130*2370*1110H (mm)

在暮色渐浓的时候，夕阳将天空染成了橙红色，落日余晖映照大地，将这种柔和的、浪漫的、迷人的、温暖的、梦幻的光，缓缓渡入室内，仿佛是大自然为我们准备的一场盛宴，让人感受到生命的美好。

In the twilight, the setting sun colors the sky orange-red, and the afterglow of the setting sun reflects on the earth, ferrying this soft, romantic, fascinating, warm and dreamy light slowly into the room, as if it is a feast prepared by the nature for us, making people feel the beauty of life.

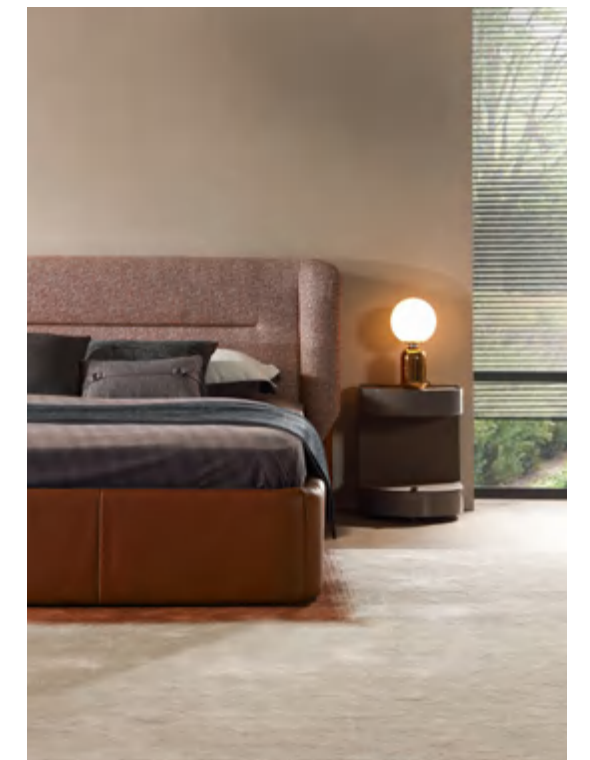
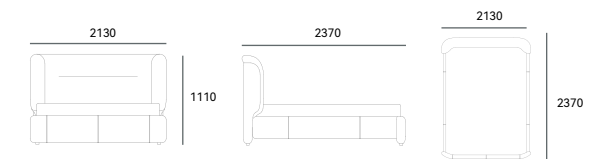





TIME

时光

编号: HT215 床

主材: 内架多层实木板、不锈钢

尺寸: 2010*2250*1150H (mm)

Model: HT215 Bed

Main material: Solid wood, Stainless steel

Size: 2010*2250*1150H (mm)

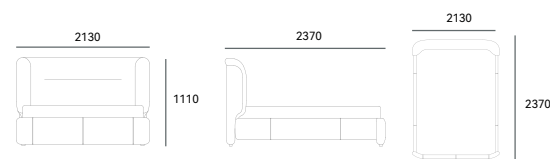

设计理念源自对时间本质的深刻洞察和对生活品质的不懈追求。它不仅仅是睡眠的载体,更是个人品味与生活哲学的体现。它鼓励人们在忙碌的生活中寻找一片属于自己的静谧之地,无论是沉浸在书海中,还是在安静的夜晚沉思,都是对内心世界的滋养与丰富。

The design concept comes from a deep insight into the essence of time and the unremitting pursuit of quality of life. It is not only a carrier of sleep, but also a reflection of personal taste and philosophy of life. It encourages people to find their own quiet place in their busy lives, whether it is immersed in a sea of books or meditating in a quiet night, it is a nourishment and enrichment of the inner world. By blending tradition and modernity, practicality and aesthetics, function and emotion, a space is created that is both a place of rest and a haven for the soul.



HT215A 床
尺寸: 2420*2250*1150H (mm)







CURTAIN

幕布

编号: HT228 床

主材: 内架实木、内架多层实木板

尺寸: 2110*2250*1170H (mm)

—

Model: HT228 Bed

Main material: Solid wood

Size: 2110*2250*1170H (mm)

幕布双人床如同一块悬挂并自由垂下的厚实的幕布，它的设计理念是将每个人的生活视为一部精彩的剧本，它鼓励人们在自己的生活中扮演主角，充满戏剧感和张力，让睡眠这项私密活动的体验更为自由浪漫。舒展的床屏简约而富有线条感，两端微微地上翘并向内包裹，带来充足而又不易察觉的安全感。

The Curtain double bed is reminiscent of a hanging and free-flowing thick curtain, symbolizing life as a captivating script and prompting individuals to take charge of their own lives. The extended bed screen, simple and linear, offers a subtle sense of security with its slightly upturned and inward-wrapped ends.

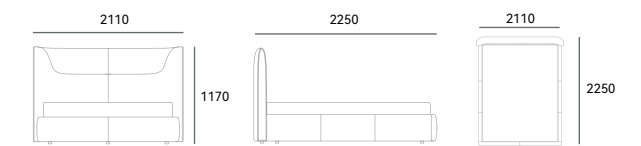

床的表面可以选择高质感的真皮或柔软的布艺，真皮款式散发着奢华与成熟，给人予经典耐看的风格；而布艺款式则带来温馨舒适和轻松的氛围。

The surface of the bed can be made of high-quality leather or soft fabric, and the leather style exudes luxury and maturity, giving people a classic and durable style; Fabric styles, on the other hand, bring a warm, comfortable and relaxed atmosphere.







MEMORY 记忆

如果说家是时间沉淀的形状，那么床作为最私密的家具，就是个体记忆的最佳存储区，高大而饱满的靠背有着微微倾斜的边角，打造房间的多层次质感，造型整体稳固扎实，躺卧其中，书写自在云端的惬意。

If a house is a reflection of time, then the bed, being the most private piece of furniture, serves as the optimal storage space for personal memories. Its tall backrest with slightly tilted corners adds a multi-dimensional texture to the room, while its stable, robust shape provides a comfortable and freeing space to rest and write.

编号: HT252 床

主材: 内架实木、内架多层实木板

尺寸: 2200*2450*1100H (mm)

Model: HT252 Bed

Main material: Solid wood

Size: 2200*2450*1100H (mm)

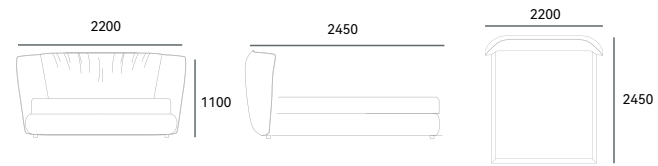



COUNT

伯爵

编号: HT238K 床

主材: 内架实木、内架实木多层板、不锈钢

尺寸: 2500*2400*1280H (mm)

—

Model: HT238K Bed

Main material: Solid wood, Stainless steel

Size: 2500*2400*1280H (mm)

充满时尚感的双人床，流露优雅风范和精湛工艺，床头采用全软包设计，带来柔和温暖的视觉效果。少数派擅长制造惊喜，特别设计的两侧托盘，方便放置一些小物件，贴心有趣，细腻的美好藏在生活各处，是理想的休息港湾。

The stylish double bed exudes elegance and exquisite craftsmanship, with a fully upholstered headboard providing a soft and warm visual effect. Surprises await with specially designed trays on both sides for conveniently placing small items, adding thoughtfulness and charm to the space.

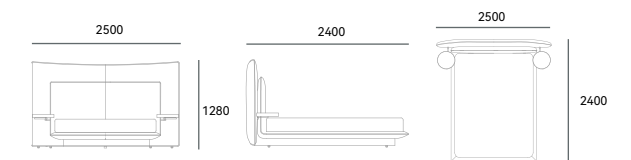

BOAT

轻舟

编号: HT261 床

主材: 内架多层实木板、A3 钢、不锈钢、亚克力

尺寸: 2140 (含盘) *2330*1100H (mm)

—

Model: HT261 Bed

Main material: Solid wood, Level of steel, Stainless steel, Acrylic

Size: 2140 (Shelves included) *2330*1100H (mm)

亚克力床脚的悬浮设计，如同一叶轻舟，驶向梦的彼岸。
床屏简约、舒展、自然，简练，没有任何多余的装饰使它
可以契合任何风格的卧室空间，为整个卧室空间拂去浮华
与喧嚣，灵动的呼吸感应运而生。

The suspended design of the acrylic bed foot is like a boat sailing towards the other side of dreams. The bed screen is simple, stretched, natural and concise, without any unnecessary decoration, making it suitable for any style of bedroom space. It removes the glitz and noise from the entire bedroom space, and creates a smart breathing feeling.

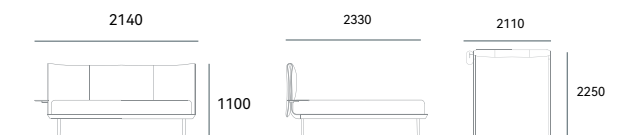

ISLAND

自由岛

编号: HT262 床

主材: 内架多层实木板、A3 钢、亚克力

尺寸: 1980*2170*970H (mm)

—

Model: HT262 Bed

Main material: Solid wood, Level of steel, Acrylic

Size: 1980*2170*970H (mm)

ISLAND 床以其独特的隐藏式的底脚设计，去繁从简的形体，仿佛一座漂浮于大海的岛屿，是一款在功能和美学上达到绝佳平衡的极简设计。让我们在纯净的光阴里找到属于自己的宁静与美好。

With its unique hidden foot design, the ISLAND bed is a minimalist design that achieves an excellent balance of function and aesthetics. Let us find our own tranquility and beauty in pure time.

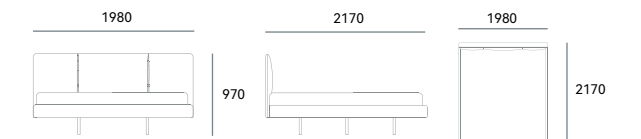

WAFFLES

华夫饼

编号: HT267 床

主材: 内架多层实木板、A3 钢

尺寸: 2020*2260*1090H (mm)

—

Model: HT267 Bed

Main material: Solid wood, Level of steel

Size: 2020*2260*1090H (mm)

华夫床方正的造型有着强烈的个性，表面一格格小方块，像极了松软柔韧的华夫饼，是造型艺术与材质的有趣融合。方正给予人更好的安全感与仪式感，让睡眠空间中的我们更加踏实与稳健，设计者让一切我们所想要的融于巧思之中，为我们带来不一样的生活灵感。

The square design of the waffle bed exudes a bold personality, with its surface resembling soft and flexible waffles. This fusion of plastic art and materials by the founder provides a sense of security and ritual, offering practicality and stability in our sleeping space. The designer's ingenuity seamlessly integrates our desires, inspiring different aspects of life.

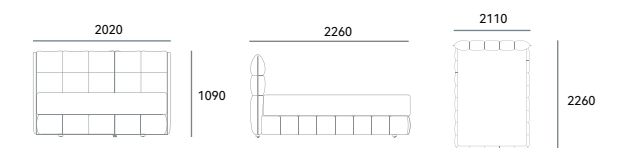

SKETCH

素描

编号: HT266 床

主材: 玻璃钢、不锈钢、内架多层实木板、A3 钢、马鞍皮

尺寸: 1980*2300*1030H (mm)

—

Model: HT266Bed

Main material: FRP, Stainless Steel, Solid Wood, Level Of Steel, Leather

Size: 1980*2300*1030H (mm)

纯粹自然的内心才能带来幸福的酣眠。素描双人床以低饱和的舒适面料，润物细无声般融入空间，一呼一吸，体会简约之美。舒适的靠垫给生活以质感之美，让人或宁静或沉思，也为人们提供舒适的睡眠保障。

A pure and untainted heart leads to peaceful sleep. The SKETCH double bed, composed of soft, low-saturation fabrics, seamlessly integrates into the surrounding space, offering tranquility and simplicity. The comforting cushions exude beauty and promote a peaceful and comfortable sleep experience, fostering a sense of calm contemplation.

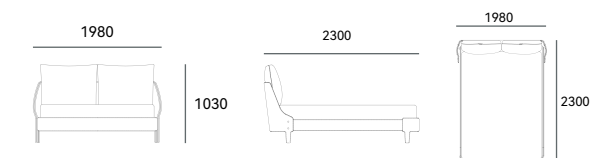

BEDSIDE TABLE

床头柜

PIONEER

不规则

编号: HT252A 床头柜

主材: HDF 高密度板、不锈钢

尺寸: 800*420*470H (mm)

Model: HT252 Nightstand

Main material: HDF, Stainless steel

Size: 800*420*470H (mm)

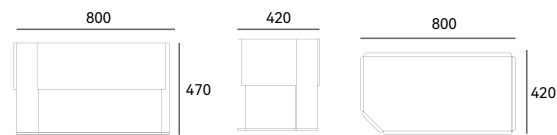

编号: HT252 床头柜
尺寸: 550*420*470H (mm)



BELLA

贝拉

编号: HT276 床头柜

主材: HDF 高密度板、不锈钢

尺寸: 440*380*470H (mm)

Model: HT276 Nightstand

Main material: HDF, Stainless steel

Size: 440*380*470H (mm)

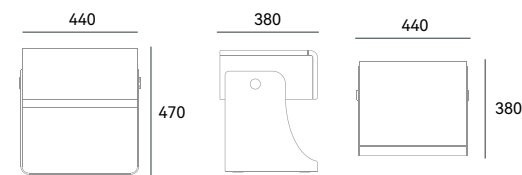

TIME

时光

编号: HT228 床头柜

主材: HDF 高密度板、染色白橡木皮、不锈钢

尺寸: 600*430*500H (mm)

Model: HT228 Nightstand

Main material: HDF, Solid wood, Stainless steel

Size: 600*430*500H (mm)

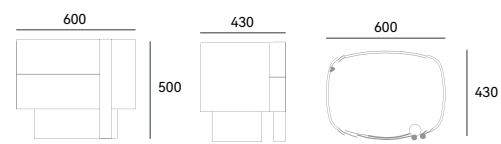

SONGS OF TIME

颂时

编号: HT267 床头柜

主材: HDF 高密度板

尺寸: 450*430*550H (mm)

Model: HT267 Nightstand

Main material: HDF

Size: 450*430*550H (mm)

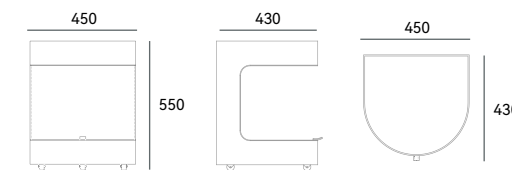

CRESCENT MOON

弯月

编号: HT218 床头柜

主材: HDF 高密度板、染色白橡木皮、不锈钢

尺寸: 560*485*530H (mm)

—

Model: HT218 Nightstand

Main material: HDF, Solid wood, Stainless steel

Size: 560*485*530H (mm)

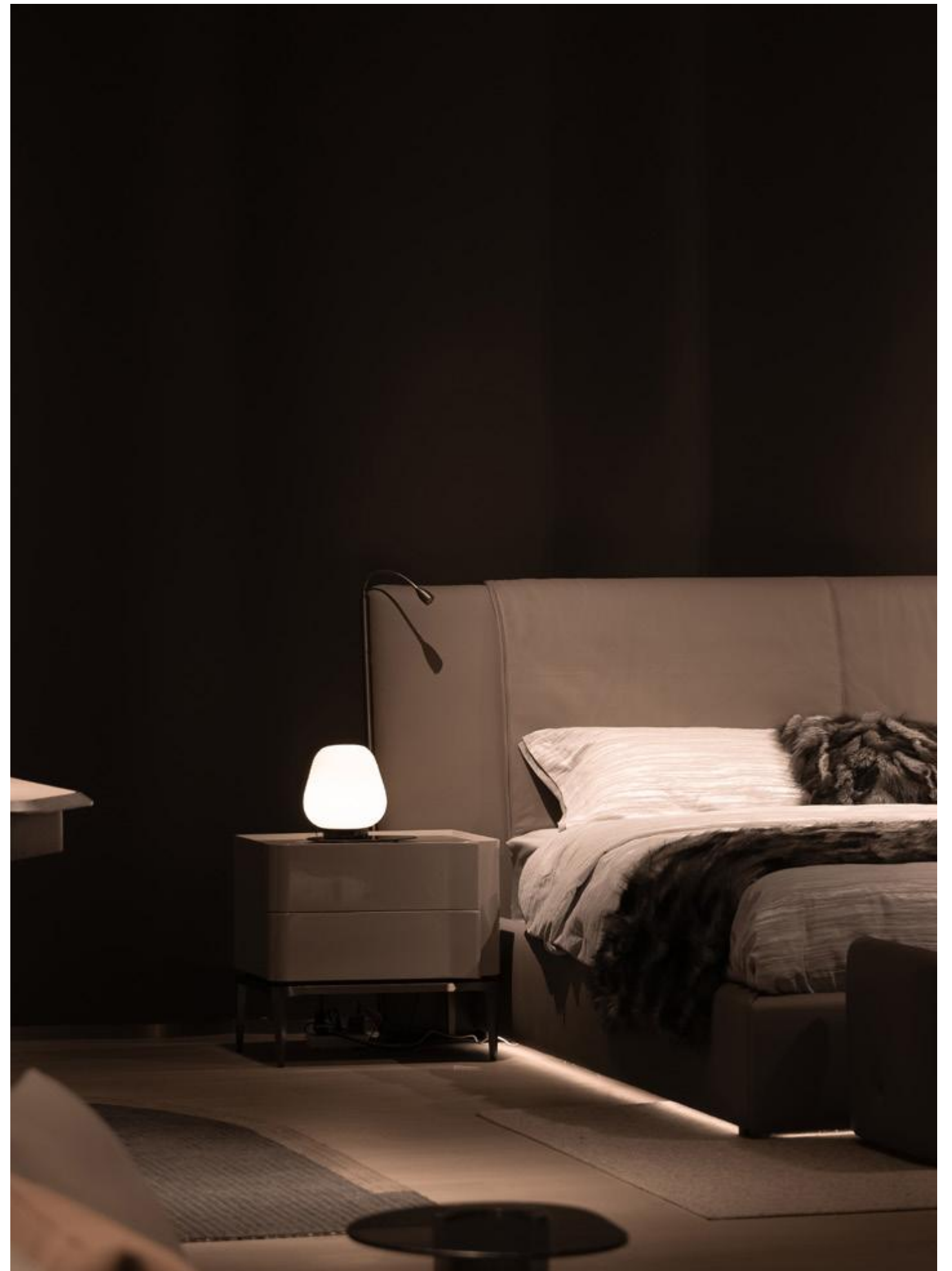
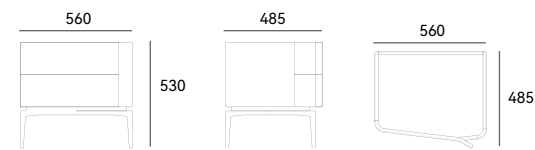

MUSHROOM

蘑菇

编号: HT237 床头柜

主材: HDF 高密度板、染色白橡木皮、不锈钢

尺寸: $\Phi 470 \times 470H$ (mm)

—

Model: HT237 Nightstand

Main material: HDF, Solid wood, Stainless steel

Size: $\Phi 470 \times 470H$ (mm)

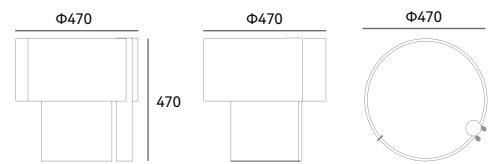

BEDSIDE

圆

编号: HT227 床头柜

主材: HDF 高密度板、染色白橡木皮、石材

尺寸: $\Phi 425 \times 460H$ (mm)

—

Model: HT227 Nightstand

Main material: HDF, Solid wood, Stone

Size: $\Phi 425 \times 460H$ (mm)

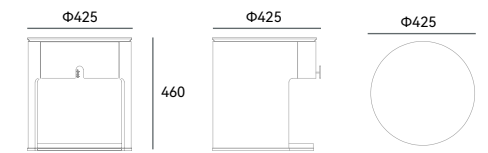

STOOLS

凳类

BALLET

芭蕾

编号: HT277 梳妆凳

主材: 玻璃钢、不锈钢

尺寸: 540*590*680H (mm)

—

Model: HT277 Armchair

Main material: FRP , Stainless steel

Size: 540*590*680H(mm)

愿你是披荆斩棘的女将军，也是令人疼爱的小女生。一把为美而生的梳妆椅，异域情调、现代感、优雅，是ta的关键词，献给每一位温柔而坚韧的女孩。Ballet 梳妆凳的核心理念在于美学与可用性的协同，椅子婀娜多姿的形态捕捉了芭蕾舞者的优雅与美的本质，唤起了精致奢华的感觉。

Embodying both strength and beauty, the Ballet dressing chair is tailored for the modern, elegant, and fearless female. The chair's graceful design mirrors the charm and grace of a ballet dancer, blending aesthetics and functionality for the refined woman.

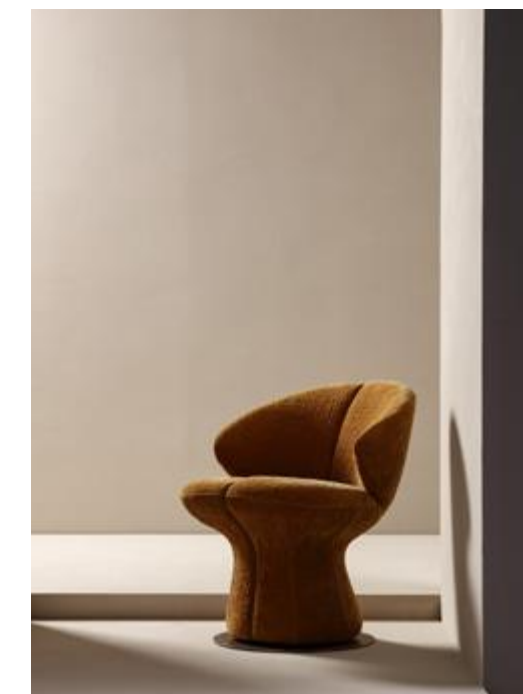
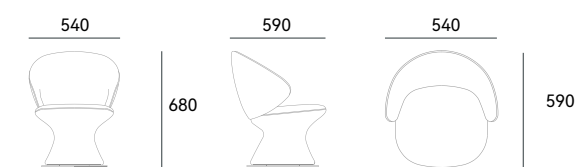

MEMORY

记忆

编号: HT268 床尾凳

主材: 内架多层实木板、不锈钢

尺寸: 1550*520*440H (mm)

Model: HT268 Nightstand

Main material: Solid wood, Stainless steel

Size: 1550*520*440H (mm)



PIANO KEYS

钢琴键

编号: HT269 床尾凳

主材: 内架多层实木板、不锈钢

尺寸: 1500*400*440H (mm)

Model: HT269 Nightstand

Main material: Solid wood, Stainless steel

Size: 1500*400*440H (mm)



CORRIDOR

回廊

编号: HT227 床尾凳

主材: 内架实木、内架多层实木板

尺寸: 1480*450*400H (mm)

—

Model: HT227 Nightstand

Main material: Solid wood

Size: 1480*450*400H (mm)

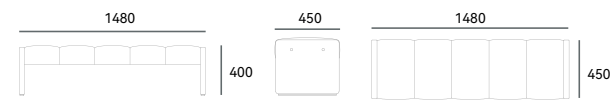

ROCK

跳岩座墩

编号: HT269 床尾凳

主材: 内架实木、内架多层实木板、不锈钢

尺寸: 600*390*430H(mm)

—

Model: HT269 Nightstand

Main material: Solid wood, Stainless steel

Size: 1500*400*440H (mm)

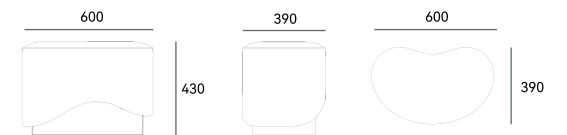

DESSING TABLE

梳妆台

TERRACE

梯田

编号: HT228 梳妆台

主材: HDF 高密度板、染色白橡木皮、马鞍皮、不锈钢

尺寸: 1300*690*830H (mm)

—

Model: HT228 Dressing table

Main material: HDF, Solid wood, Leather, Stainless steel

Size: 1300*690*830H (mm)

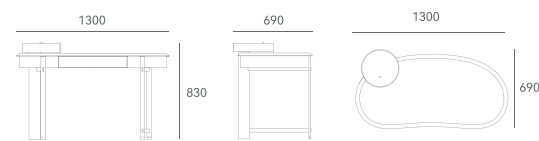

梯田梳妆台有着更加柔和圆润的线条, 像一汪小小的水潭, 赋予内敛娴静的优雅气质。带着微微弧度的桌面更加符合人体工学, 桌面旁的斜角连接着覆盖整张真皮的桌面, 使用时的每一丝触感都更加舒适。

The Terrace dresser, with its softer and more rounded lines, resembles a small puddle, giving it a restrained and elegant temperament. The slightly curved table top is more ergonomic, and the beveled angle next to the top connects to the top that covers the entire leather, making every touch more comfortable to use.



POETRY

诗歌

编号: HT268 梳妆台

主材: 石材、HDF 高密度板、染色白橡木皮、不锈钢

尺寸: 2160*740*720H (mm)

—

Model: HT268 Dressing table

Main material: Marble, HDF, Solid wood, Stainless steel

Size: 2160*740*720H (mm)

不规则的弧形桌面，简约而大气，同时散发出强烈的建构魅力，容量充足的柜体和自带置物平台的桌腿，共同构成稳定的支撑，释放腿部空间的宽敞自由，可打开的桌面的圆形盖板，每一处细节都充满巧思，像写下几行婉转的小诗，方寸间能够装满质感生活也能唤醒审美的重塑与独立。

The elegantly irregular curved desktop exudes a robust structural charm. The cabinet provides ample storage capacity while the table legs include their own storage platform for added stability. The details of the circular desktop cover are meticulously designed, akin to eloquent poetry. This furniture fills small spaces with quality living and evokes an aesthetic transformation and independence.



桌面采用真皮材质覆盖，散发出柔软细腻质感。收纳柜顶部则选用优质石材打造，营造出内敛沉稳的视觉效果。桌腿采用开放式的圆弧造型设计，与悬挂在桌腿上的圆形收纳盒形成和谐呼应。整体造型简约大气，散发出一股时尚摩登的气质。

The desktop is covered with genuine leather, exuding a soft and delicate texture. The top of the organizer is made of high-quality Marble, creating a restrained and calm visual effect. The table legs adopt an open arc design, which harmoniously echoes the circular storage box hanging from the table legs. The overall design is simple and atmospheric, exuding a sense of modern fashion.

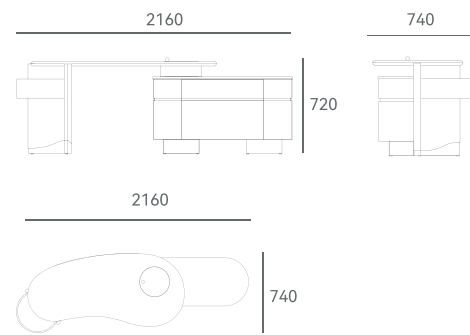

Study Systems

书房空间

TERRACED

梯田

编号: HT228 书台

主材: HDF 高密度板、染色白橡木皮、马鞍皮、不锈钢

尺寸: 1870*850*750H (mm)

—

Model: HT228 Desk

Main material: HDF, Solid wood, Leather, Stainless steel

Size: 1870*850*750H (mm)





一间激发灵感的好书房，开启求知的能量场。灵感源于世界遗产名录的云南梯田，将哈尼族人 1300 多年来生生不息雕刻成的山水田园，化作少数派的独立设计语言。层叠错落的梯田，洗练明晰的设计笔触，硬朗的弧度，带来更加舒适且冷静的工作氛围。

A well-designed study space, inspired by the terraced fields of Yunnan, creates an energizing environment for knowledge pursuit. The Hani people's landscape has influenced the unique design language, characterized by stacked terraces and clear, concise design elements, fostering a calm and conducive working atmosphere.





GEOMETRIC 几何

编号: HT228 书架

主材: HDF 高密度板、染色白橡木皮、马鞍皮

尺寸: 2420*400*1900H (mm)

—

Model: HT228 Bookshelf

Main material: HDF, Solid wood, Leather

Size: 2420*400*1900H (mm)

造型灵感来自蒙德里安的抽象艺术，以不拘一格的精神，探索少数派摩登艺术之路，当蒙德里安遇上曲线，横向与纵向叠加，被赋予移动的魔力，柜门的色彩与圆润的细节触感，从多个维度变幻出无穷效果。

The shape is inspired by Mondrian's abstract art, and explores the path of minority modern art with an eclectic spirit. When Mondrian encounters curves, horizontal and vertical superpositions are given the magic of movement, and the color and roundness of the cabinet door The detailed touch creates endless effects from multiple dimensions.

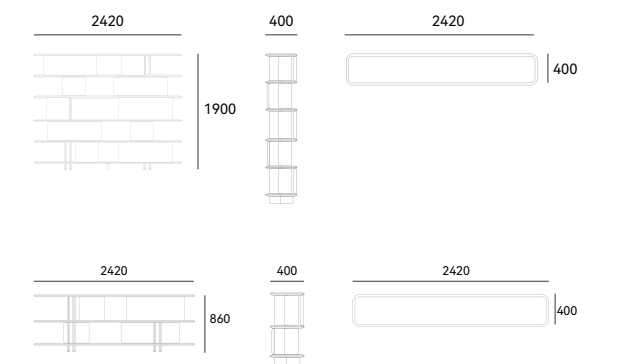

PUZZLE

拼图

编号: HT265 书台

主材: 不锈钢、HDF 高密度板 + 榆木皮

尺寸: 1800*750*750 (mm)

Model: HT265 Desk

Main material: Solid wood, Leather, Stainless steel

Size: 1800*750*750 (mm)

灵感来源于拼图游戏，多个模块错落拼接而成，方块的组合具有强烈的现代感，造型极简、干练。桌面采用皮革和木材结合，突显品质感。实木经过碳化工艺处理之后更加坚硬美观。

Inspired by jigsaw puzzles, multiple modules are spliced together at random. The combination of blocks has a strong sense of modernity, and the shape is minimalist and capable. The table top is made of leather and wood, highlighting the sense of quality. Solid wood becomes harder and more beautiful after carbonization treatment.

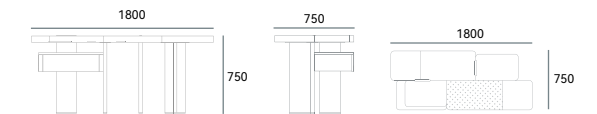



ARC

曲面

编号: HT227 书台

主材: HDF 高密度板、染色白橡木皮、不锈钢

尺寸: 1600*700*730H (mm)

Model: HT227 Desk

Main material: HDF, Solid wood, Stainless steel

Size: 1600*700*730H (mm)

书台以现代简约设计为特点，简于造型，精于材质，曲面的桌腿设计兼顾方正的序列感，拥有天然的烟熏木色，风格利落而不乏优雅，以简单的方式创造独特的生活风格，带来足够专注的空间，为书房增添一份高级感。

The desk embraces a modern and minimalist design, with simple yet refined materials. Its curved table legs complement the clean and elegant style, adding a touch of sophistication to any study space while providing ample room for concentration.

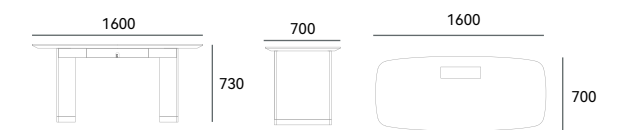

THE PUZZLE

拼图

编号: HT265 书椅

主材: 内架实木

尺寸: 570*600*880H (mm)

—

Model: HT265 Chair

Main material: Solid wood

Size: 570*600*880H (mm)

拼图书椅是一款融合了现代美学与自然元素的扶手椅，以拼图的设计灵感为基础，结合独特的扶手和靠背拼接设计，展现出独特的设计美感，同时确保了扶手椅的结构稳固性和舒适性，为用户带来舒适的坐感和极致的视觉享受。

The Jigsaw Book Chair combines modern aesthetics with natural elements, inspired by the jigsaw puzzle design. Its unique armrest and backrest splicing design ensures structural stability and comfort, providing a comfortable and visually captivating experience for the user.

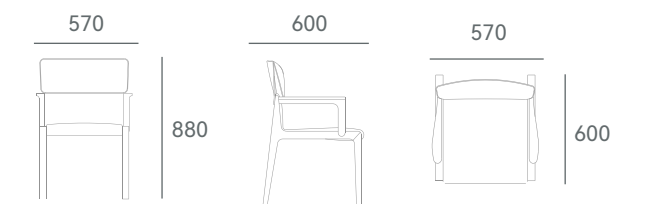

Tea Systems

茶室空间



HERMIT

隐逸

编号: HT268 茶台

主材: 石材、HDF 高密度板、染色白橡木皮、不锈钢、铜

尺寸: 2400*1060*700H (mm)

Model: HT268 Table

Main material: Marble, HDF, Solid wood, Stainless steel, Brass

Size: 2400*1060*700H (mm)

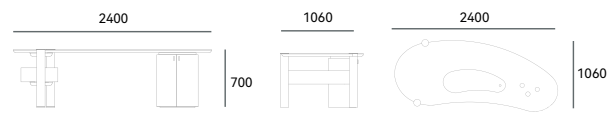

采用不规则的桌面打破工整感，多几何的立体穿插营造出浮空感，多材质交叠碰撞，呈现百搭的小众设计力，一扫茶桌既定的笨重感，纤细与厚重的桌腿分别置于两侧，搭配半月形的小型置物台，令整张茶席仿佛悬浮在水面上一般，隐逸之处，一隅可安。

The asymmetric tabletop disrupts uniformity, while the combination of various geometries gives a floating effect. By integrating different materials, a versatile niche design is achieved, replacing the traditional bulkiness and thick legs of a typical tea table. Accompanied by small half-moon-shaped storage tables on either side, the overall design creates the illusion of a serene floating retreat on water.





GENTLEMAN

绅士

编号: HT227A 茶台

主材: HDF 高密度板、染色白橡木皮、不锈钢、石材

尺寸: 1800*660*700H (mm)

—

Model: HT227A Table

Main material: HDF, Solid wood, Stainless steel, Marble

Size: 1800*660*700H (mm)

一款现代风格的茶台，轮廓简约且造型精致，精选材质，包括实木和精细饰面，搭配木框架和皮革嵌件的搁板，勾勒出精致的曲线，柔化了涂漆金属结构的强线条，采用中性灰色结构，营造出更加果断和严谨的色调，是空间内不可或缺的陈设。

A modern tea table with sleek outlines and refined materials such as solid wood and exquisite veneers. It features a wooden frame, leather-inserted shelves, and a lacquered metal structure. The strong lines and neutral gray tone exude a determined and strict aesthetic, making it an essential piece of furniture in any space.

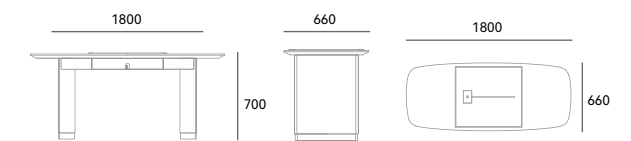

MODULE

模块

编号: HT227 茶柜

主材: HDF 高密度板、染色白橡木皮、不锈钢、铝框玻璃门

尺寸: 1600*360*1635H (mm)

—

Model: HT227Cabinet

Main material: HDF, Solid wood, Stainless steel, Aluminum alloy

Size: 1600*360*1635H (mm)

追求, 高级材质和简练设计, 打磨细节, 满足简逸却精致的微妙诉求, 优雅几何, 干净利落, 通过线条、色调、工艺、材质等多方面达到美学的统一, 去繁就简, 用最洗练的笔触, 描绘出最丰富灵动的空间效果。

Pursuit, high-grade materials and concise design, polishing details, to meet the simple but delicate subtle appeal, elegant geometry, clean and neat, through lines, tones, technology, materials and other aspects to achieve aesthetic unity, to simplify the complex, with the most refined brushstrokes, depicting the most rich and flexible space effect.

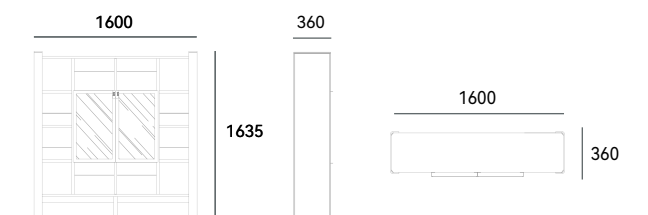

MINIMALISM

极简系列

编号: HT227K 烧水台

主材: HDF 高密度板、染色白橡木皮、不锈钢、岩板

尺寸: 530*360*570H (mm)

Model: HT227K Table

Main material: HDF, Solid wood, Stainless steel, Rock slabs

Size: 530*360*570H (mm)

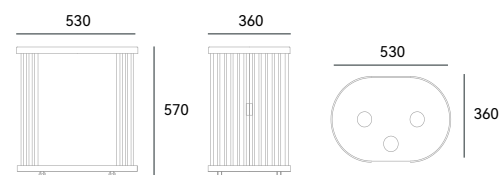

EMBRACE

拥

编号: HT269 烧水台

主材: 石材、HDF 高密度板、染色白橡木皮

尺寸: 440*400*545H (mm)

Model: HT269 Table

Main material: Marble, HDF, Solid wood,

Size: 440*400*545H (mm)

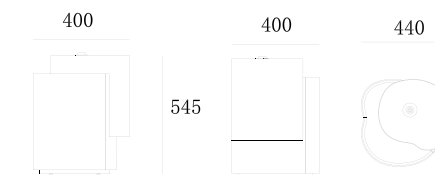

ERYA

尔雅

编号: HT227K 茶椅

主材: 内架多层实木板、不锈钢

尺寸: 570*510*730H (mm)

—

Model: HT227K Chair

Main material: Solid wood, Stainless steel

Size: 570*510*730H (mm)





MOUND

山丘

编号: HT269 茶椅

主材: 内架多层实木板、不锈钢

尺寸: 640*650*750H (mm)

—

Model: HT269 Table

Main material: Solid wood, Stainless steel

Size: 640*650*750H (mm)

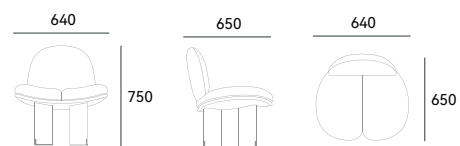

BABY

小屁孩

编号: HT260 茶椅

主材: 玻璃钢、不锈钢

尺寸: 500*490*475H (mm)

—

Model: HT260 Chair

Main material: FRP, Stainless steel

Size: 500*490*475H (mm)

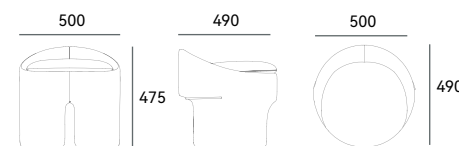

ANCILLARY

配套家具

XUN 埧

编号: HT268 木墩

主材: 白蜡木

尺寸: 510*300*400H (mm)

—

Model: HT268 Cabinet

Main material: Solid wood

Size: 510*300*400H (mm)

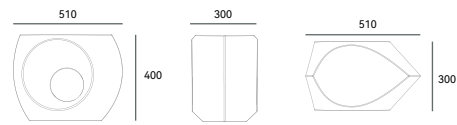

追求, 高级材质和简练设计, 打磨细节, 满足简逸却精致的微妙诉求, 优雅几何, 干净利落, 通过线条、色调、工艺、材质等多方面达到美学的统一, 去繁就简, 用最洗练的笔触, 描绘出最丰富灵动的空间效果。

Pursuit, high-grade materials and concise design, polishing details, to meet the simple but delicate subtle appeal, elegant geometry, clean and neat, through lines, tones, technology, materials and other aspects to achieve aesthetic unity, to simplify the complex, with the most refined brushstrokes, depicting the most rich and flexible space effect.



ARCH

拱门

编号: HT268 玄关台

主材: 石材、HDF 高密度板、不锈钢

尺寸: 1500*500*730H (mm)

—

Model: HT268 Cabinet

Main material: Marble, HDF, Stainless steel

Size: 1500*500*730H (mm)

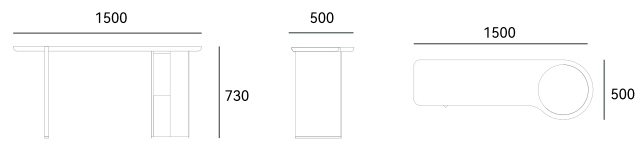

FOLDING

折叠

编号: HT260 屏风

主材: HDF 高密度板、不锈钢

尺寸: 1840*40*1720H (mm)

Model: HT260 Screen

Main material: HDF, Stainless steel

Size: 1840*40*1720H (mm)

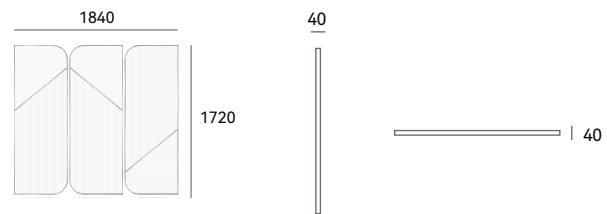

少数派的空间分割美学，折叠屏风从折纸艺术启发思考，一片平面材料，通过折叠，可以实现结构上的无限可能，随性改变空间形式，弧形的设计，有一种天然的温柔，既能划分空间，亦能增添意境之美。

The aesthetics of space division of the minority, the folding screen is inspired by origami art, a flat material, through folding, the infinite possibilities of the structure can be realized, the form of the space can be changed casually, and the arc-shaped design has a natural tenderness, which can not only divide the space, but also add the beauty of artistic conception.



屏风整体采用了仿佛折纸般的几何造型，呈现出一种富有动感的三维感。这种折叠立体的设计，不仅增添了视觉趣味性，也让整体造型更具艺术感和创意性。

The entire screen adopts an origami-like geometric shape, presenting a dynamic three-dimensional feel. This folding three-dimensional design not only adds visual interest, but also makes the overall shape more artistic and creative.



CALLIGRAPHY

折笔

编号: HT268 衣帽架

主材: HDF 高密度板、榆木皮、不锈钢

尺寸: 1160*450*1600 (mm)

—

Model: HT268 Coat racks

Main material: Solid wood, Stainless steel

Size: 1160*450*1600 (mm)



灵感源自古代书法中的“折笔”技巧，设计师将笔锋的转折与力度变化转化为三维几何结构，通过 Z 字型的形态展现出一种流动感与力量感。衣帽架的每一部分仿佛都是书法中的一笔一划，既是实用的家具，也是空间中的艺术雕塑。通过这种设计，书法的韵律与力道得以在现代家居中重现，赋予作品独特的文化深度和艺术价值。

Inspired by the technique of "folding the pen" in ancient calligraphy, the designer transforms the turning and dynamic changes of the brush into a three-dimensional geometric structure, showing a sense of flow and power through the Z-shaped shape. Each part of the coat rack seems to be a stroke in calligraphy, which is both a practical piece of furniture and an artistic sculpture in the space. Through this design, the rhythm and strength of calligraphy can be recreated in modern homes, giving the work a unique cultural depth and artistic value.

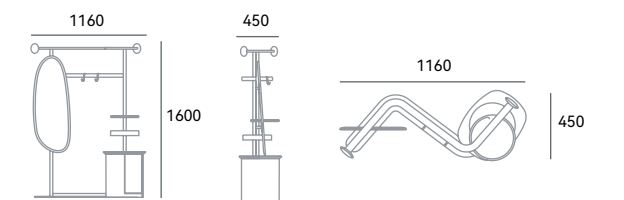

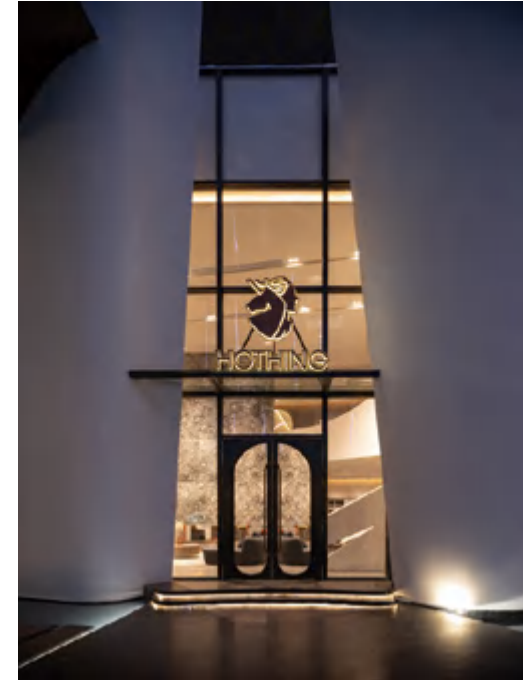

深圳市和信国际家居有限公司 官网: <http://www.hothing.vip>

VIP 服务热线: 4000 999 039